

PARADE, INSPECTION
AND BASIC
EVOLUTIONS
OF THE
INFANTRY BATTALION
4TH EDITION

BEING

A MANUAL FOR COMPANY OFFICERS,
NON-COMMISSIONED OFFICERS AND SOLDIERS
OF CIVIL WAR LIVING HISTORY UNITS
ON THE MOVEMENTS OF
A BATTALION OF
INFANTRY.

BY

COL. DOMINIC J. DAL BELLO
ARMY OF THE PACIFIC

PARADE, INSPECTION
AND BASIC
EVOLUTIONS
OF THE
INFANTRY BATTALION

4TH EDITION

BEING

A MANUAL FOR COMPANY OFFICERS,
NON-COMMISSIONED OFFICERS AND SOLDIERS
OF CIVIL WAR LIVING HISTORY UNITS
ON THE MOVEMENTS OF
A BATTALION OF
INFANTRY.

BY

COL. DOMINIC J. DAL BELLO
ARMY OF THE PACIFIC

To: Mother

Without whose patience and understanding of my early interests, this work would never have been possible.

4th Edition

Copyright © 1998 by: Dominic J. Dal Bello
Santa Barbara, CA

Revised to 4th Edition, June, 1998.

3rd Edition

Copyright © 1996 by: Dominic J. Dal Bello
Santa Barbara, CA

Revised to 3rd Edition, March, 1996.

1st & 2nd Editions

Copyright © 1994 by: Dominic J. Dal Bello
Santa Barbara, CA

Revised to 2nd Edition, December, 1994.
First Edition, October, 1994.

All rights reserved. Reproduction in any manner of any part of this work without the written permission of the author is prohibited.

Preface to the 4th Edition

Along with experiencing some of a soldier's life with good parads, one of the exciting aspects of Civil War living history is the continuous effort to learn more, and then to apply our research to improve our impressions. To stop searching for - and sharing - knowledge is to let the passion die. This author is also "cursed" with having a deep drive to attempt to make any project "better." Thus the 4th Edition of "PIE."

While the Forward remains valid, a Preface is necessary to introduce some of the changes from the 3rd Edition, and to provide additional comments.

In this edition, there are some minor changes to the wording and figures (*i.e.*, fuller explanations), as well as a few additions. It is hoped that these changes have not subtracted from the value of the work.

Of significance is an improved description of the *Assembly of the Battalion* - forming the Battalion line - in its own "chapter" (Paras. 184-186). The more efficiently a Battalion is formed, the sooner it can be taken into the field. A table has also been added that summarizes the positions of the company commander, guides, Color Rank and general guides in the various movements (pg. 66), as well as an inset on general rules for *successive formations* (pg. 40).

For the most part, the numbering of paragraphs has remained consistent with previous editions - up to Para. 121. The section on the *Column Doubled on the Center* has been incorporated into the main body. Thus, Paras. 162-181 in the 3rd Edition are now Paras. 122-141 in the 4th Edition; this has of course affected the numbering of the later sections.

The reader is thus cautioned when referencing specific paragraphs - the edition number is also important.

More "Notes" have been appended at the end - one on casualties and another on route marches by the flank.

Review continues to be omitted; the focus of this manual has been on daily *Parade*, safety (*Inspection*), and movements in the field. Those who wish to study *Review* are referred to the 1861 *U.S. Army Regulations*, Paras. 349-374; the author hopes that "PIE" may be of some help in understanding this ceremony. It should be noted that in passing in review, only the officers salute, and the men and guides do not turn their heads (*Army Regulations*, Para. 358).

The terms "Battalion Commander" and "company commander" (the posts) continue to be used in this work - as

opposed to "Colonel" and "Captain" (the grades) of the original works; there is of course no grade of "Commander" in the Army. The author desired to make the designations as generic as possible; not all Battalions (companies) are commanded by Colonels (Captains). "Battalion Commander" is capitalized to distinguish it from "company commander."

As always, *the reader is strongly encouraged to consult the original manuals.* This is especially true for the field officers, the Adjutant and the Sergt. Major, as well as for the company officers and sergeants. It is upon these men that the effective functioning of the Battalion rests. Being familiar with the *Tactics before* reaching the drill field is often the difference between a crisp drill session done well, and a long one done badly. Battalion Commanders should endeavor to hold "schools" for their officers and sergeants *before* going onto the field. Preparation will help avoid confusion, embarrassment, and most importantly, the men standing idly in ranks longer than necessary.

One advantage of the "higher schools" of *Tactics* is that, in general, only the "basic" drill from the "lower school" is needed; *i.e.*, marching in line, wheels, turns, flank movements and *by company into line* make up the components of nearly all Battalion movements. A key concept to understand is that this "synchronized company drill" requires a common reference - a line - which is why the company guides (and markers) are important. The reader will note that in the maneuvers, the post of company left guide ("2nd Sergt.") is at times the most critical in the company as it moves in relation to the others.

On the "battlefield," theory meets "reality," and a strict adherence to the details of the *Tactics* is not often possible. However, having a good understanding of the *Tactics*, and the discipline and communication that comes from drill, enables a Battalion to reach the point of action as efficiently as possible, and throw its weight into the fray at the critical moment.

Each time the author reads the original manuals, he attempts to gain further insight into the *Tactics*, &c. It is hoped that the 4th Edition of *Parade, Inspection and Basic Evolutions of the Infantry Battalion* is effective in passing on some of those learnings, and that perhaps it might inspire further insights for the reader.

DOMINIC J. DAL BELLO
Colonel
ARMY OF THE PACIFIC

June, 1998

Forward

The following paragraphs and figures attempt to present in a concise and comprehensible form *Parade, Inspection* and basic *Evolutions* of a Civil War Infantry Battalion. A knowledge of the School of the Company, as given by Hardee or Casey, is assumed.

Several sections were added to the 2nd Edition to make the present work. In order that the Paragraphs of the 2nd and 3rd Editions would agree, the new sections were added at the end.

The procedures have been adopted from the *United States Army Regulations* of 1861, and the *Infantry Tactics* of both William J. Hardee and Silas Casey. *It is highly recommended that the reader consult these primary sources.* While this book attempts to present the *Infantry Tactics* in a clear manner, it is *not* meant to replace the original manuals.

Several other sources are referenced. Upton's 1874 manual is used where the *Regulations* or manuals are unclear or incomplete; *e.g.*, the communication during *Parade*, as well as the procedures for inspecting arms and knapsacks.

This "manual" was written with three individuals in mind: the company commander ("Captain"), the senior NCO ("1st Sergt.," *right guide*) and the second NCO ("2nd Sergt.," *left guide*). However, *it is desirable that every officer and enlisted man have a basic understanding of the movements.*

In general, the Battalion Commander's commands should *not* be repeated by anyone. If he can be heard, then there is no reason to "echo" him. It is therefore of the utmost importance for communication, discipline and safety that the men remain *quiet* in ranks - we should act like the soldiers we seek to portray.

In most of the figures (not drawn to scale), only the commander and the two senior NCOs of each company have been included, as they do most of the "work" in Battalion drill. The file closers will generally remain two paces behind the rear rank, unless the Battalion "closes" to half distance or *in mass*, when they close to one pace behind the rear rank.

In small Battalions, its Commander may find it practical to amend some of the methods as his staff may be limited. For example, the Commander may find it necessary to eliminate positions that are not as vital in smaller units, such as the *markers* and even the *general guides*. However, the basic procedures remain the same.

Sources

- Baxter, D.W.C., *The Volunteer's Manual*, Philadelphia: King and Baird, 1861.
- Bruce, George B. and Emmett, Daniel D., *The Drummers' and Fifers' Guide*, New York: Wm. A. Pond & Co., 1861.
- Butterfield, Daniel, *Camp and Outpost Duty for Infantry*, New York: Harper and Brothers, 1862.
- Casey, Silas, *Infantry Tactics*, Vols. I, II & III, New York: D. Van Nostrand, 1862.
- General Regulations for the Military Forces of the State of New York*, Albany: Weed, Parsons & Co., 1859 (1858).
- Hardee, William J., *Rifle and Light Infantry Tactics*, Vols. I & II, Philadelphia: J.B. Lippincott, 1861 (originally authorized and printed in 1855).
- Kautz, August V., *Customs of Service for Non-Commissioned Officers and Soldiers*, Philadelphia: J.B. Lippincott, 1864.
- Kautz, August V., *Customs of Service for Officers*, Philadelphia: J.B. Lippincott, 1866.
- Knowlton, Miner, *Instructions and Regulations for the Militia and Volunteers of the United States*, Philadelphia: Charles Desilver, 1861.
- Le Gal, Eugene, *School of the Guides*, New York: D. Van Nostrand, 1859.
- Mahan, D.H., *Advanced-Guard, Outpost and Detachment Service of Troops*, New York: John Wiley, 1861 (originally published 1847).
- Scott, Henry L., *Military Dictionary*, New York: D. Van Nostrand, 1861.
- Scott, Winfield, *Abstract of Infantry Tactics*, Boston: Hilliard, Gray, Little and Wilkins, 1830; Philadelphia: Moss, Brother & Co., 1853, 1861 (originally authorized 1829).
- Scott, Winfield, *Infantry Tactics*, Vols. I, II & III, New York: Harper & Brothers, 1840 (originally authorized and printed in 1835).
- Scott, Winfield, *Rules and Regulations for the Field Exercise and Manœuvres of Infantry*, Philadelphia: Anthony Finely, 1824 (originally authorized 1815).
- United States Army Regulations*, Washington: Government Printing Office, 1861.
- United States Infantry Tactics*, Philadelphia: J.B. Lippincott, 1861.
- Upton, Emory, *Infantry Tactics*, New York: D. Appleton & Co., 1866.
- Upton, Emory, *Infantry Tactics* (revised), New York: D. Appleton & Co., 1874.
- Viele, Egbert L., *Hand-book for Active Service*, New York: D. Van Nostrand, 1861.

THE INFANTRYMAN

The infantry soldier should bear in mind that, with whatever exultation the cavalry or artillery pass him in advancing upon the enemy, the grand result cannot be achieved without him, and that the presence of the musket and its proximity is what enables them to precede him in the fight.

- Brig. Gen'l. August V. Kautz
*Customs of Service for Non-Commissioned
Officers and Soldiers*
1864

THE BATTALION

An aggregation of two to ten companies in United States Service. Their instruction is regulated by Infantry and Light Infantry Tactics.

- Col. Henry L. Scott
Inspector General, U.S.A.
Military Dictionary
1861

Figure 1: A Battalion of ten companies in line of battle.

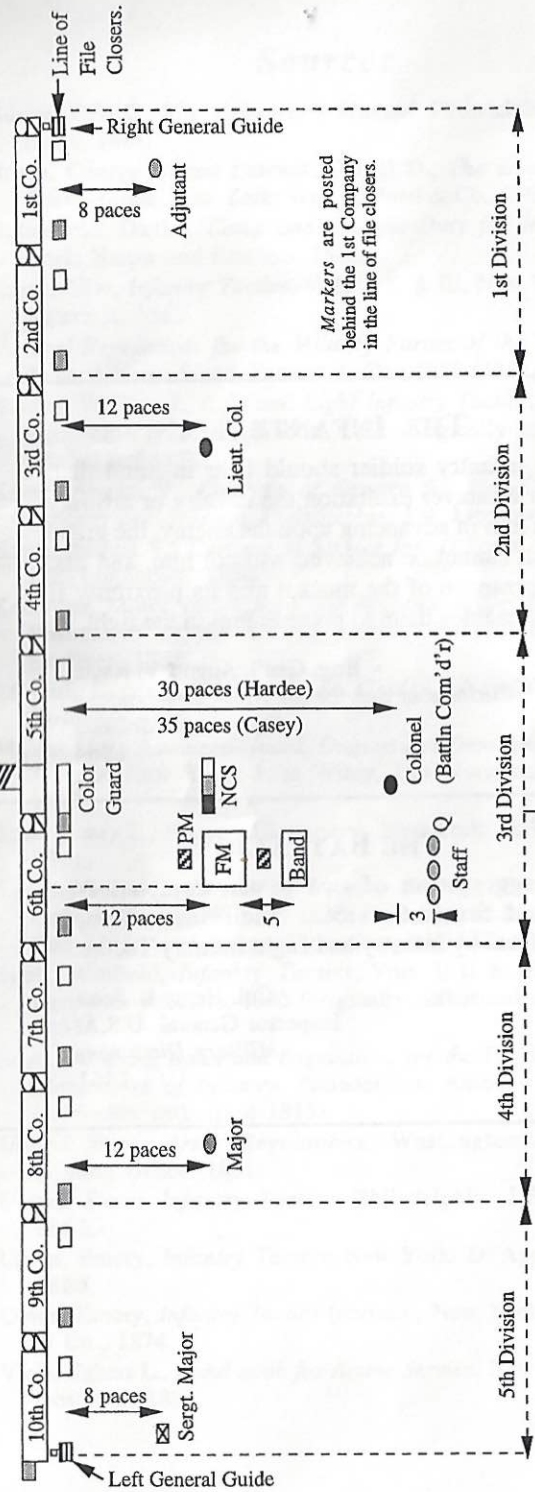

Key to abbreviations:

PM: Principal Musician.

FM: Field Music (company musicians, massed, in four ranks).

NCS: Non-commissioned staff (l-r, QM Sergt., Commis. Sergt., Hosp. Steward).

Staff: Quartermaster (Q), Surgeon, staff officers.

Left Wing Right Wing

When maneuvering, the Colonel, Lieut. Colonel, Major and staff officers are ideally on horseback; the Adjutant is on foot.

For Parade and Inspection, all officers are on foot.

A pace, as a unit of measure, is 30 inches, or two and one-half feet (Viele).

Formation of a Battalion

1. A **BATTALION** is composed of two or more companies acting together as a unit. At its initial formation, a Battalion of ten companies (e.g., a regiment) has them posted from *right to left* by seniority of their respective "Captains:" first, sixth, fourth, ninth, third, eighth, fifth, tenth, seventh and second (Cos. A, F, D, I, C, H, E, K, G, B). This distribution is made so that the five seniormost "Captains" command the five divisions.
2. With less companies, the same ordering applies: the senior and second "Captains" command the *right* and *left* companies, respectively, the third commands the *right center* company, &c. (Table I).
3. To avoid confusion when maneuvering, the companies are designated from right to left as: *first* company, *second* company, *third* company, &c., irrespective of the rank of their company commanders (Figure 1).
4. From right to left, every two companies are designated as a *division*, and numbered in the same manner as the companies. With an odd number of companies, the leftmost company will constitute a division by itself.
5. The Color Guard is posted at the left of the *right center* company (the "Color Company"), and, in general, maneuvers as part of that company; it "counts-TWOS," doubles, and wheels with that company. It does not "pivot" or wheel on itself. By the *Infantry Tactics*, in Battalions with less than five companies, there will be no display of the Color except on reviews; however, we will violate this "rule," as is often done in living history Battalions.
6. Companies to the right of the Color are designated as the *right wing*, those to the left, the *left wing*.
7. *Right* and *left general guides* may be employed, especially in larger Battalions, to help keep the Battalion's flank companies dressed on a moving line and in step, and to help give the Battalion general alignments. *Markers* (e.g., staff or enlistedmen), not necessarily the *general guides*, are used to indicate the direction of a line of battle in *successive formations*, and points of changes of direction of a column of companies. If practical, the lead *general guide* may act as one of the markers in *successive formations*.¹

¹ See Notes "On Markers," pg. 69.

8. For purposes of maneuvering, the companies are ideally equalized by transferring men from larger to smaller companies (although in living history companies, this may not be practicable). In general, the companies should be as equal in strength as possible.

9. For simplicity, the Battalion discussed hereafter will consist of four companies (Figure 2), unless noted. The same methods are used for larger or smaller Battalions. Battalion commands are numbered (1, 2, 3, &c), while company commands are lettered (a, b, c, &c). The Battalion Commander ("Colonel") is capitalized, company commanders are in lower case. As a full compliment of officers and NCOs is often lacking, we generally neglect stating ranks, or place them in quotation marks (e.g., "1st Sergt."). The positions of absent officers and sergeants (Figure 3) are filled by those next in seniority (e.g., a lieutenant or a sergeant may be the company commander; a regular sergeant, or even a corporal, may act as the "1st Sergt."). As the number of files decreases, the number of file closers is generally reduced.

TABLE I: Ideal Order of Companies by Seniority of Company Commander.

No. of Cos.	Left										Right															
	Ordering										Ordering															
3											2	3	*1													
4											2	4	*3	1												
5						2	4	5	*3	1	2	4	5	*3	1											
6				2	5	6	*3	4	1	2	5	6	*3	4	1											
7			2	4	7	6	*3	5	1	2	4	7	6	*3	5	1										
8		2	6	8	4	*3	7	5	1	2	6	8	4	*3	7	5	1									
9	2	4	8	9	5	*3	7	6	1	2	4	8	9	5	*3	7	6	1								
10	2	7	10	5	8	*3	9	4	6	1	2	7	10	5	8	*3	9	4	6	1						

Source: Upton, Emory, *Infantry Tactics*, 1874, p.150.
An asterisk, *, indicates the right center company.

This table implies that the right center company - the Color Company, usually commanded by the 3rd "captain," - is just that: the company to the right of center. In an odd-company Battalion, the right wing has one less company, and the 4th "captain" commands the company second from the left; the Color Company is not the center company. Note, also, that except in a five-company Battalion, all of the seniormost "captains" command the divisions. Ideally, a Battalion must field at least five companies to display its Color (except on *Review* and other ceremonies).

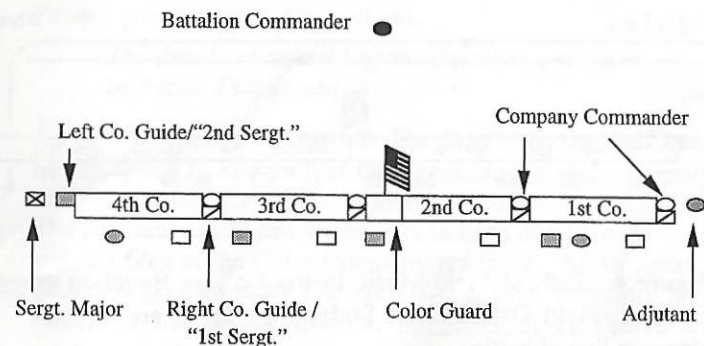

Figure 2: A Battalion of four companies formed for *Parade*. Note that we do not include a full set of file closers, nor the Color Guard's file closer rank, in the figures. The Field Music is posted to the right of the Adjutant. Not shown are the Field Officers and the Staff (in their positions in line of battle).

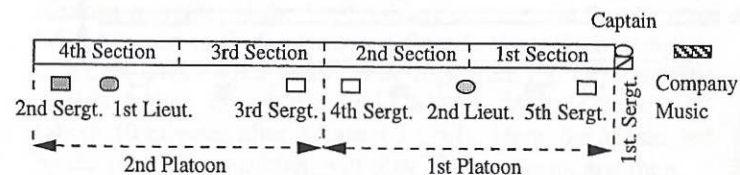

Figure 3: A single company (detached) in line of battle, with its music and a full set of file closers. File closers are two paces behind the rear rank. The music is posted 4 paces to the right of the company, the drummer on the right. Corporals post on the right and left of sections.

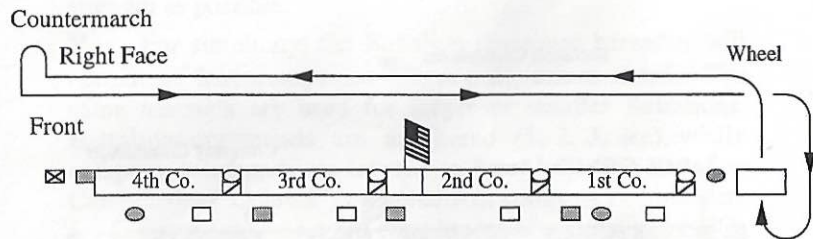

Figure 4: Path of Field Music in front of the Battalion on Parade. Field Officers and Staff, not shown, are in their places in line of battle.

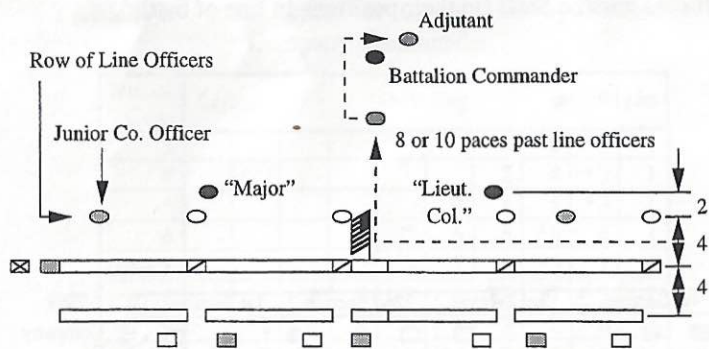

Figure 5: Battalion on Parade, with ranks opened, all company officers 4 paces in front of their companies. Note the path of the Adjutant - always around the right of the Battalion Commander. Field officers post 6 paces in front of the centers of their respective wings; when the ranks are opened, they move from their places in line of battle around the nearest flank. The Staff stays in their places in line of battle.

DRESS PARADE

10. By the Regulations, there shall be a *Dress Parade* at least once per day, unless circumstances prohibit it, at *Troop* or *Retreat* (morning or evening *Parade*). All field and company officers and men of the Battalion must attend the *Parade* unless specifically excused.

The details of assembling the Battalion are given in Para. 184, et seq.

11. When the Music sounds *The Assembly*, one-half hour before *Troop* or *Retreat* (per the Regulations), each company commander will form his command and have the roll called. The Adjutant positions two markers in front of where the right and left files of the Color Company are to lie. At *Adjutant's Call* (10 minutes after *The Assembly*), each company will march to the parade ground, bayonets fixed (being on ceremony), the Color Company preceding the others and the band (music) playing. Note that the times may need to be adjusted as a practical matter.

12. After the companies take their places in line (Figure 2), the Adjutant posts two paces to the right of the 1st company, the Field Music on his right; the Sergt. Major posts two paces to the left of the line. The "Lieut. Col.," "Major" and Staff post in their positions in line of battle (Figure 1). The senior officer present (Battalion Commander, i.e., the "Colonel") takes charge of the *Parade*, and posts in the front center of the Battalion, at a practical distance to oversee it. All officers are on foot.

13. The Adjutant, having verified or corrected the alignment of the companies, orders "*Guides-POSTS*" (Para. 184). He then indicates to the 1st company commander that he may bring his men to *Order Arms* and *Parade Rest*. Each company will then *Order Arms* and *Parade Rest* from right to left. The Adjutant then orders the Field Music, "*Music, beat off*" (about 10 minutes after *Adjutant's Call*). Here, the Music, led by the principal musician, will play *Three Cheers*, and then

march to the left, playing the 'Troop,' ... to the left of the line, there they will face to the right [the Battalion's front], and counter-march to the left; when at the proper signal [from its chief], they again face to the front [the Battalion's right], and march back to their proper place on the right of the line,²

playing a quickstep (Figure 4).

² Bruce, George B. and Emmett, Daniel D., *The Drummers' and Fifers' Guide*, 1861, pg. 38.

AUTHOR'S NOTE on Para. 13: The 1861 *Army Regulations* (Para. 339) state that the company commander "steps one pace to the front" to command *Order Arms* and *Parade Rest*. This seems to be done so that the company can hear him, and so the Adjutant can see the progression down the line. He no doubt should also face to the left to give the commands. We suggest that the commander is to step back into ranks after giving the order (although not in the *Regulations*), as there is no other reason or precedent for him to be one pace in front. Upton's *Tactics* is not helpful at first, as directly after the War, officers post in front of their companies when forming line for Parade; but Upton does provide a clue - an NCO in command of a company posts in the front rank - to give the order to *Parade Rest*, he steps forward, faces left, gives the order, and then returns to ranks (Upton, '74, Para. 811).

14. After the Music returns to the right, the Adjutant steps two paces to the front, faces left, and orders:

1. *Attention.* 2. *Battalion.*
3. *Shoulder-ARMS.* 4. *Prepare to open ranks.*
5. *To the rear, open order.* 6. *MARCH.*

(Figure 5) At "...*open order*," all the "1st Sergts." (*right guides*) and only the leftmost company's "2nd Sergt." (*left guide*), move four paces in rear of the front rank; the other file closers do not move until "*MARCH*." At "*MARCH*," the ranks open, all of the company officers moving to positions four paces in front of their companies, opposite their places in line of battle, the subalterns moving through their company commander's interval. The "1st Sergts." replace their company commanders in the front rank when the rear rank has been aligned. The field officers advance six paces in front of the center of their wings, moving around the nearest flank. If an NCO commands a company, he does not move into the line of officers, but stays in the front rank; his acting "1st Sergt." remains in the rear rank.

15. When the ranks are aligned, and the rear rank dressed, the Adjutant commands:

FRONT.

He will then march (between the front rank and the line of company officers) along the front of the Battalion to the center, face front, march eight to ten paces past the company officers, face about and command:

Present-ARMS.

Seeing this executed, he will face about to the Battalion Commander, salute, and report:

Sir, the parade is formed.

16. The Battalion Commander (without sword drawn), acknowledges the salute, and if he desires to drill the Battalion in the "Manual of Arms," directs the Adjutant to "*Take your post, sir*," (three paces leftward and one in rear of the Commander). The Adjutant (always) moves around the Commander's right. The Battalion Commander, drawing his sword, will then order:

1. *Battalion.* 2. *Shoulder-ARMS.*

followed by any other exercises he desires, concluding with:

Order-ARMS.

Returning his sword, the Battalion Commander directs the Adjutants to receive the company reports. If there is no drill, the Commander will not require the Adjutant to take his post.

17. Upon direction from the Battalion Commander, the Adjutant will pass around the Commander's right (or face about if not posted), advance midway between the Commander and the line of company officers, and order:

1. *1st Sergeants, to the front and center.*
2. *MARCH.*

At the first command, the senior NCO ("1st Sergt.") of each company will *Shoulder Arms*, march forward two paces and face inward (toward the center). At "*MARCH*," they move to the center and halt.

18. The Adjutant will then order:

1. *Front-FACE.* 2. *Report.*

From right to left (1st company to last), the "1st Sergts." will salute with arms (by bringing the left hand across to the right shoulder, palm down), and give the result of their roll calls. For example, "*Co. A, all present or accounted for*." Or, if there are those absent without authorization; the "1st Sergt." states the number, e.g., "*Co. F, one corporal and two privates absent*."

19. Having received the reports, the Adjutant orders:

1. *1st Sergeants, outward-FACE.*
2. *To your posts-MARCH.*

at which, the NCOs will retake their places and *Order Arms*.

20. When the "1st Sergts." have returned to their places, the Adjutant will face the Battalion Commander and give him the names of absent officers, and the result of the reports, e.g., "Sir. All present or accounted for." or "Sir. _____ enlisted men are absent." Note that the Adjutant will not necessarily need to add the company reports in his head - he will already know the answer from the Morning Reports turned in earlier (neglecting any changes).

21. Then, upon direction from the Battalion Commander to "Publish the orders, sir," the Adjutant faces the Battalion and orders:

Attention to Orders.

at which time he will read the day's orders and other announcements. After these announcements, the Adjutant will face the Commander, salute him and report, "Sir. The orders are published." The *Parade* will then be dismissed, or may pass immediately to *Inspection*, if desired (ideally, *Inspection* follows a *Review*³).

22. If the *Parade* is to be dismissed ("Dismiss the parade, sir.") the Adjutant announces:

Parade is Dismissed.

All the company and field officers sheath their swords, face inward, and march towards the center, where the Adjutant will be, having moved onto their line. The two center officers will leave a space for the Adjutant, and the field officers ("Lieut. Colonel" and "Major") will post on the flanks of the officers. The Adjutant will then order the officers to:

1. Front-FACE. 2. Forward-MARCH.

They will march, the music playing, to within six paces of the Battalion Commander, halting at the Adjutant's "HALT," and salute the Commander; the music will cease. The Battalion Commander will then give them any other instructions, and then indicates that the *Parade* is dismissed. After the Battalion Commander dismisses the officers, each "1st Sergt." may close his ranks and march his company to its own parade (street) where it will break ranks. When the officers disperse, the music plays until the companies have left the Battalion parade.

³ See *United States Army Regulations*, 1861, Paras. 349-374.

INSPECTION

23. If an *Inspection* is to follow the *Parade*, the Adjutant, upon direction from the Battalion Commander, will cause the ranks to be closed, by ordering:

1. Prepare to close ranks. 2. Close Order.
3. MARCH.

At "Close order," the officers will face about; at "MARCH," the ranks close, and the officers return to their places in line of battle. The subaltern officers will return to their posts by taking two paces towards their respective companies, face left (the Battalion's right), and move around their company's right flank. The Adjutant retakes his post behind the Commander (Para. 16). All officers are on foot; bayonets are still fixed.

24. The Commander will next cause the Battalion line to break into a *column of companies* with the following:

1. By company. 2. Right wheel. 3. MARCH.

(Figure 6) At "Right wheel," the company commanders place themselves two paces in front of the center of their companies, cautioning their men in undertones of the intended movement; the "1st Sergts." fill their vacancies. At "MARCH," the rightmost front rank man of each company simply faces right to the left arm of the "1st Sergt.," the company commander moves to where the left of his company will lie after completing the 90° wheel, and the *left guide* ("2nd Sergt.") guides the fixed-pivot wheel as soon as his left flank is cleared; the *right guide* ("1st Sergt.") remains facing front. When the *left guide* is three paces from his company commander, that commander orders "___ Company, HALT," positions the *left guide* on the perpendicular facing the new direction, and orders "Left-DRESS;" this dress is within each company - it is not a general Battalion guide - the right of each company should remain on the line that was the Battalion's *front*. At "FRONT," the "1st Sergt." aligns himself with the company, and the company commander returns to the front center of his company.

25. The *column of companies* being formed, the Battalion Commander directs the Adjutant to march the Color Guard to a point ten paces in front of the column; the Band moves to a point ten paces in rear; the Field Musicians will join their respective companies. The Commander orders:

1. *Battalion.* 2. *To the rear, open order.*
3. **MARCH.**

At "... *open order*," the "1st" and "2nd Sergts." move four paces behind their front rank. At "**MARCH**," the ranks of each company will open; when the rear rank is aligned, the "1st" and "2nd Sergts." return to the front rank.

26. The Battalion Commander then orders:

1. *Officers and Sergeants, to the front of your companies.* 2. **MARCH.**

(Figure 7) Company officers will form in one rank, eight paces in front and along the whole front of their companies, from right to left by seniority (Capt., 1st Lieut., 2nd Lieut.). The "1st Sergt." and NCO file closers will do likewise, six paces in front, also moving around the company's right flank.⁴ The company musicians (and pioneers) will move four paces in front of their respective companies. The Battalion Commander then orders:

Field and staff, to the front-MARCH.

The field and staff officers form one rank along the whole front of the column, by seniority from right to left, six paces in front of the Color; the NCO staff, likewise, four paces in front of the Color. The Battalion Commander prepares to receive the Inspector, if any.

27. The Commander (and Inspector) passes once down the column and back, observing the Battalion's general appearance. The Battalion Commander will then command:

1. *Order-ARMS.* 2. *In place-REST.*

The rearmost companies in a large Battalion may stack arms. The inspecting party passes down the column a second time inspecting the arms, accoutrements and dress of the men. As the party approaches each company, its commander orders:

- a. *Attention.* b. *Company.* c. *Inspection-ARMS.*

⁴ As the file closers pass around the right flank, they arrive in order from junior to senior, and thus form in front of the company in an efficient manner. The "2nd Sergt." should move behind the front rank, wait for the last file closer to pass, and then move around the right flank.

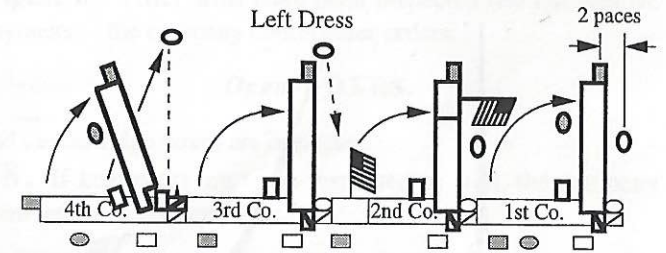

Figure 6: "By company, right wheel." Breaking from line of battle into a column of companies - right in front. At "MARCH," the rightmost front rank man of each company simply faces right to the left arm of his "1st Sergt.," who remains facing in the original direction until the company is ordered by its commander to "Left-DRESS. FRONT," as emphasized in the figure by the 4th company. Note that the dress is within each company - the right of each company is still on the line that was the Battalion's *front*.

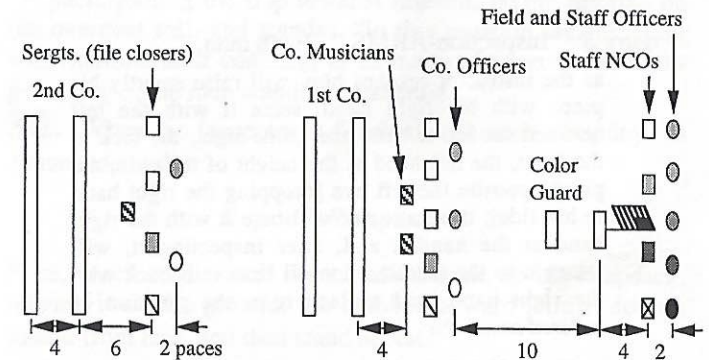

Figure 7: *Inspection.* Field and Staff, Color Guard, and first two companies in column, with ranks open. In each line of Officers or NCOs, seniority is from right to left. The file closers always move around the company's right flank. Here, we show a near-ideal staff and 1st company officer structure.

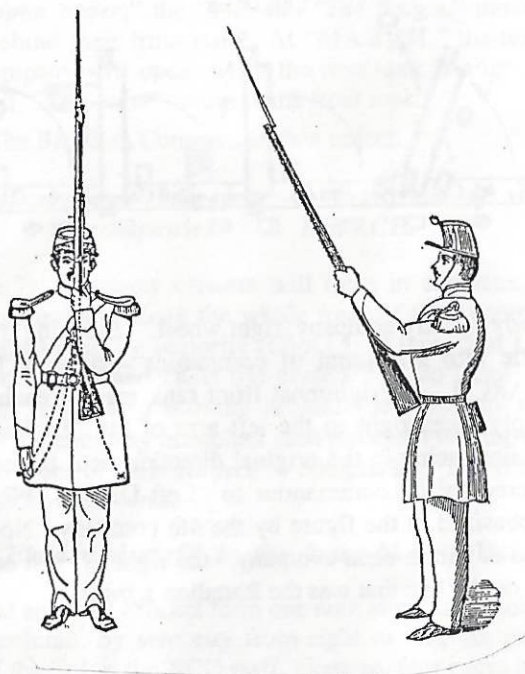

Figure 8: "Inspection-ARMS." Each man,

as the instructor reaches him, will raise smartly his piece with his right hand, seize it with the left between the lower band and guide sight, the lock to the front, the left hand at the height of the chin, the piece opposite the left eye [dropping the right hand to his side]; the instructor will take it with the right hand at the handle, and, after inspecting it, will return it to the recruit who will receive it back with the right hand, and replace it in the position of *ordered arms*.

Side View: *U.S. Infantry Tactics*, "School of the Soldier," Para. 229.

Front View: Baxter's *The Volunteer's Manual*, Fig. 102.

Hardee, Vol. I, Para. 229. Casey, Vol. I, Para. 238. Upton, 1874, Para. 112 ["dropping the right hand;" neither Hardee nor Casey specify what to do with it when presenting the piece].

At which, each man prepares his weapon for inspection. The inspecting party will then inspect the arms of the men (Figure 8). After arms have been inspected (do not remove bayonets),⁵ the company commander orders:

Open-BOXES.

and the cartridge boxes are inspected.

28. If knapsacks are to be inspected as well, the company commander next commands:

- a. *Shoulder-ARMS.* b. *Close order.* c. **MARCH.**
- d. *Order-ARMS.* e. *Stack-ARMS.*
- f. *To the rear, open order.* g. **MARCH.**
- h. *Front rank - about - FACE.*
- i. *Unslung-Knapsacks.* j. *Open-Knapsacks.*

At the first "MARCH," the file closers close on the center in order to stack their arms in front of the company. At "FACE," the file closers face outward and return to their positions along the whole front of the company.

29. At "Unslung," each man removes his knapsack, and standing erect, holds it in front of his knees by the straps. At "Knapsacks," the pack is placed on the ground, the number upward (*i.e.*, the straps down), the greatcoat (rolled) near his feet, and stands. At "Open-Knapsacks," each soldier opens his pack, pulling the flap towards himself, laying the flap on the overcoat roll, and stands. "In this position the Inspector will examine their contents, or as many of them as he thinks necessary ... the men standing at attention."⁶

30. When the Inspector is finished with each company, its commander orders:

Repack-Knapsacks.

Here, "each soldier will repack and buckle up his knapsack, leaving it on the ground, the number upward [straps down], turned from him, and then stand at rest."⁷

⁵ The reader may note that in Casey's "School of the Soldier" (Para. 230), the bayonet is removed after the piece is inspected. However, if the Battalion is at a ceremony (*Parade, Inspection, &c.*), bayonets remain fixed. Also, if knapsacks are inspected, the arms will need to be stacked.

⁶ *United States Army Regulations*, 1861, Para. 316.

⁷ *United States Army Regulations*, 1861, Para. 317.

31. The company commander then orders:

- a. *Attention.* b. *Company.* c. *Sling-Knapsacks.*
- d. *Front rank - about - FACE.* e. *Close order.*
- f. *MARCH.* g. *Take-ARMS.* h. *Shoulder-ARMS.*
- i. *Officers and Sergeants to your posts.*
- j. *MARCH.*

At "*Sling*," each man picks up his knapsack by the straps, and stands. At "*Knapsacks*," he will put his pack on. The reverse of **Para. 28** is then executed. When the ranks close, the file closers close together to retake their arms. The officers and sergeants return to their posts as in a *column of companies* (**Figure 6**).

32. After being inspected, each company (and the staff), may return to camp except for the Color Company, as per the *Regulations*. However, it is suggested that the Commander have inspected companies rest in place so that the Battalion may be marched off or dismissed as one entity.

33. To save time, the Battalion Commander may wish to inspect all the Battalion's arms first, and then come back down the column a third time for knapsacks; he will then not need to wait on each company as it prepares its packs. With a view to further save time, he may also have the Field Officers inspect their own wings, or company officers inspect companies. Also, because of small unit sizes and few file closers in the reenacting community, the Battalion Commander may find it practical not to order the officers and sergeants to the front, and simply keep the company commanders two paces in front of their companies.

EVOLUTIONS

34. While company drill and the mastery of it are vital, the main tactical unit is the *BATTALION*. Battalion drill consists of several companies doing company drill together, so it is not as complicated as one may initially think.

35. In general, what is done by company may be done by division (or platoon), by substituting "*division*" for "*company*." If *by division*, only the senior company commander of each division will do what is prescribed for the company commander. The junior commander will take post in front of the "1st Sergt." of the left company of his division, who may or may not be his own "1st Sergt."

36. Also, what is done *to the right*, may be done *to the left* by using inverse means, *i.e.*, substituting "*left*" for "*right*," or "*right*" for "*left*," "2nd Sergt." for "1st Sergt.," &c.

37. The *left guide* ("2nd Sergt.") of each company generally remains in the line of file closers, unless his company's left flank becomes uncovered. The *left guide* of the *leftmost* company is posted in the front rank of the Battalion (he is traditionally called the "closing sergeant"); the *left guide* of the Color Company is posted to the left of the Color Guard's file closers (behind the next company's "1st Sergt."). In line, there should be no gap between a company commander and the leftmost file of the company to his right. In the figures, file closers, and the field and staff, have been generally omitted. The reader should note, however, that file closers may be called upon to perform the duties of company commander, company *right* or *left guide*, *markers*, *general guides*, &c. And while they are not to give or repeat commands, &c.,

Files closers will not be allowed to consider themselves a mere ornament to the rear of the company. They will be more particularly held responsible for the alignment of the ... rear [rank], of which they will judge by the squareness of shoulders and the touch of elbows. ... In battle, the arms of the file closers are often well employed in preventing the ranks from breaking to the rear.⁸

Figure 9 depicts a Battalion of four companies in line of battle.

⁸ Scott, Winfield, *Infantry Tactics*, 1835, Para. 33.

Marching by the Flank

38. From a halted line of battle, to march *by the right flank*, the Battalion Commander will order:

1. *Battalion.* 2. *Right-FACE.* 3. *Forward.*
4. **MARCH.**

or, if moving:

1. *Battalion.* 2. *By the right flank.* 3. **MARCH.**

(Figure 10) As in company drill, the ranks "double" upon facing or moving by a flank (unless the men are ordered not to double). The guide is left - on the side of the front rank. The left guide of the leftmost company moves to the left of the last file of his company, in line behind the company commanders.⁹ Not shown are the "Lieut. Col.," "Major," Adjutant and Sergt. Major, whose posts are prescribed in **Para. 165**. To change the direction of march, the Battalion Commander will order:

1. *By file right (left).* 2. **MARCH.**

and the Battalion changes its line of march as in company drill. Only the Battalion Commander gives the command; company commanders do not (nor are any sword movements prescribed in the manuals).

39. To return to line of battle, the Commander simply orders:

1. *Battalion.* 2. **HALT.** 3. **FRONT.**

or, to continue marching,

1. *By the left flank.* 2. **MARCH.**

and the column *by the flank* undoubles to the front into line.

40. Facing or marching *by the left flank* (Figure 11) is performed by the same principles, substituting "*left*" for "*right*." When moving *by the left flank*, the guide is right (to the side of the front rank) and each company commander

⁹ When the Battalion is at *route step*, the company commander generally falls back to the rear of his company to observe that the men remain in ranks. See Notes "On Route Marches by the Flank," pg. 73.

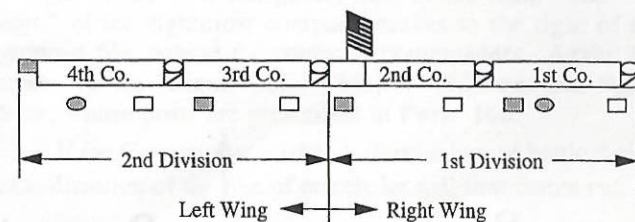

Figure 9: Battalion of four companies in line of battle. The Field and Staff are not shown (see Figure 1).

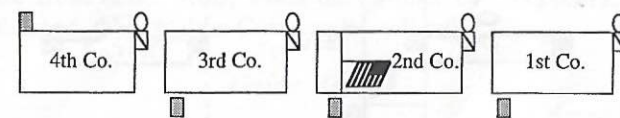

Figure 10: Battalion faced by the right flank (doubled). The leftmost "2nd Sergt." is in the line of company commanders.

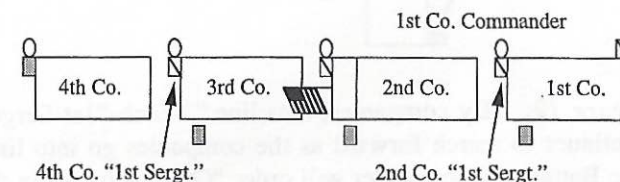

Figure 11: Battalion faced by the left flank (doubled). The commander of each company moves to the right of the "1st Sergt." of the company to the left; the leftmost company commander moves to the right of his own "2nd Sergt."

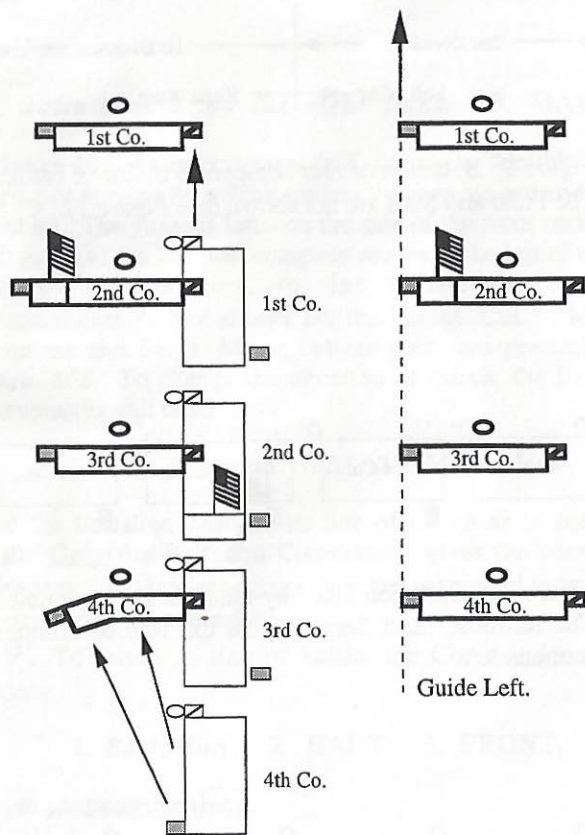

Figure 12: "By companies, into line." Each "1st Sergt." continues to march forward as the companies go into line. The Battalion Commander will order "Guide left" when the column of companies is established.

moves to the right of the right guide ("1st Sergt.") of the company to his left in line (now in front of him), with the exception of the leftmost company commander, who posts to the right of his own left guide, now in the lead. The "1st Sergt." of the rightmost company moves to the right of the rightmost file, behind the company commanders. Again, not shown are the "Lieut. Col.," "Major," Adjutant and Sergt. Major, whose posts are prescribed in **Para. 166**.

41. If the Commander wishes to form a line of battle facing in the direction of the line of march, he will first command:

1. *By companies, into line.* 2. **MARCH.**

(Figure 12) Here, each "1st Sergt." will continue to march forward, and each company will go into line, one behind the other, forming a *column of companies*, which may be deployed into line by the methods described in **Para. 80, et seq.** The companies **DO NOT** form one line. The company commanders move to the front of their companies, two paces in front; the right and left guides ("1st." and "2nd Sergeants.") are in the front rank. Also, when the *column of companies* is established, the Battalion Commander will order,

Guide left.

The guide of a column, *right in front* (i.e., rightmost company in front), is generally to the *left*. If the column is *left in front* (leftmost company in front), the guide is generally to the *right*.

From Line into Column

Wheeling to the Right or Left

42. To break a line of battle into a *column of companies* (divisions, platoons), *right in front* (1st company in the lead), the Battalion Commander orders:

1. By company. 2. Right wheel. 3. MARCH.

The companies wheel as prescribed in **Para. 24**, and shown again in **Figure 13**. To review, at "*wheel*," the company commanders move to the front center of their companies and caution them in undertones to wheel, the "1st Sergts." filling their vacancies. At "**MARCH**," the rightmost front rank man simply right faces to the left elbow of his "1st Sergt.," the "2nd Sergt." guides the fixed-pivot wheel, and the commander moves to where the left of his company will lie after completing the 90° wheel. Three paces before completing the wheel, the commander halts the company, the left guide posts on the perpendicular, and the company is dressed to the left; the "1st Sergt." remains facing in the original direction until the company is dressed and fronted.¹⁰ The right of each company should still be on the line marking the original *front* of the Battalion.¹¹ The column, *right in front*, at full (company) distance, may then be moved forward by the commands:

1. Column, forward. 2. Guide left. 3. MARCH.

the column moving off as in **Para. 59**. Forming the column may also be executed while the line is moving, the companies wheeling on fixed pivots.¹²

¹⁰ To form the column, *left in front* (left company in the lead), substitute "*left wheel*" for "*right wheel*." At "**MARCH**," the leftmost front rank man of each company faces left, and the "1st Sergt." guides the wheel; the "2nd Sergt." moves into the front rank when his left flank is clear (his right arm against the leftmost front rank man's chest), and remains facing in the original direction until the company is dressed.

¹¹ This allows the column to face about and wheel by company back into a Battalion line. Only when the column begins to move forward is the Battalion guide generally shifted to the left.

¹² See Notes "Concerning Wheels," pg. 71.

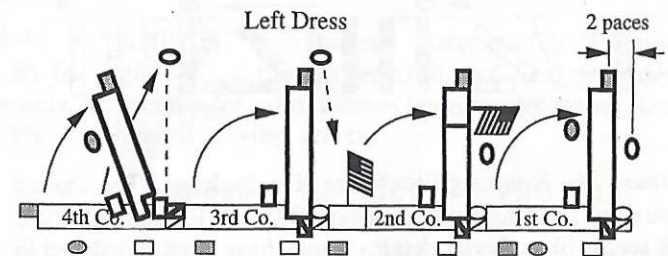

Figure 13: "By company, right wheel." Breaking from line of battle into column of companies - right in front.

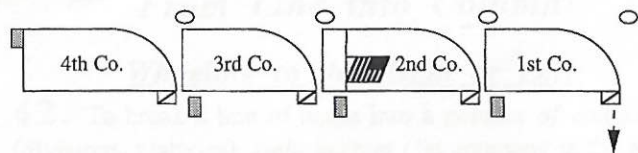

Figure 14: Breaking files to the rear.

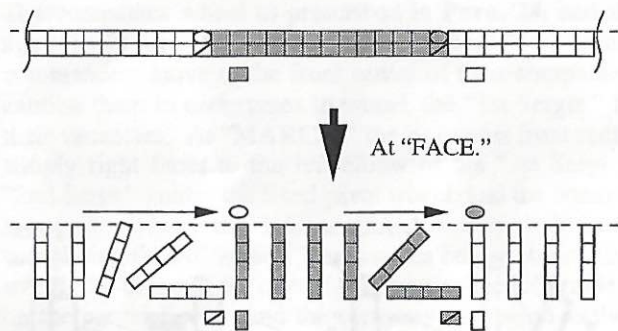

Figure 15: Breaking files to the rear, in detail. The shaded company is doing Hardee's (Plate 33, Vol. II; although Plate 58 seems like a better detail - it may have been misplaced in the original manual); the light company on the left is doing Casey's (Plate 2, Vol. II). The Battalion Commander should specify which to do. -

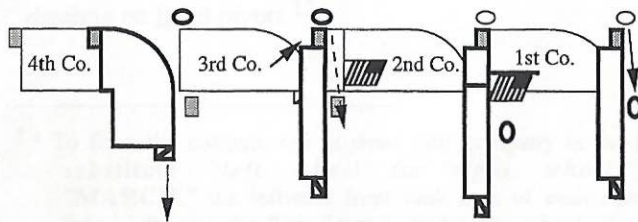

Figure 16: After breaking files to the rear, each company marches towards the rear at the Battalion Commander's "MARCH." When the last file of each company has wheeled, its commander will halt and front it. The left guide will then post on the line that was the Battalion's front, his left arm against his commander's chest; the company is then dressed to the left.

To Break to the Rear

43. The Battalion Commander will order:

1. *By the right of companies to the rear into column.*
2. *Battalion, right-FACE.*
3. *MARCH.*
4. *Guide left.*

(Figure 14) At the first command, each company commander moves to the front and center of his company, cautioning it to face right. At "FACE," the company commander moves to the right of his company and breaks two files (three, according to Casey) to the rear (Figure 15), and then positions himself so that his breast lightly touches the left arm of the leftmost front rank man of the company to the right. The men of the first file should be in line with the right shoulders of the rear rank men, the "1st Sergt." facing toward the rear.

44. At "MARCH," each company marches off as if doing a *By file right*. When the last set of files of each company wheels, its commander, who watches his company march past without he himself moving, orders:

- a. *___ company.*
- b. *HALT.*
- c. *FRONT.*
- d. *Left-DRESS.*

(Figure 16) At "c. FRONT," the left guide of each company automatically moves up so that his left arm lightly brushes the breast of his company commander. The company dresses on the guide at "DRESS." Note that the left of each company is on the line which was the Battalion's *front*. After dressing, the commander again orders, "FRONT," and then moves to the front center of his company.

45. If the line had been marching, the Battalion Commander orders "2. ...*by the right flank*. ...," instead of "...*right-FACE*." When the last file has wheeled towards the rear, the Battalion Commander orders:

4. *Battalion, by the left flank - MARCH.*
5. *Guide left.*

and the column of companies will march off in the new direction without halting.

46. Breaking files may also be done *to the left* and/or *to the front*. However, breaking to the rear, "being at once the most prompt and regular, will be preferred on actual service, unless there be some particular reason for breaking to the front."¹³

Closed Column Facing Same Direction

47. A closed column (six pace intervals between company guides) may be formed facing the same direction as the halted line of battle with the following commands:

1. *Close column by company.*
2. *On the 1st company, right in front.*
3. *Battalion, right-FACE.* 4. *MARCH.*

(Figure 17) At "right in front," the company commanders will move to the front center of their companies, cautioning them to face right; the 1st company is cautioned to stand fast. At "FACE," all but the designated ("base") company (here the 1st) will face right, the company commanders slightly breaking the lead two files to the rear. At "MARCH," the company commanders will guide their companies so that an interval of six paces separates each company guide in column. The left guide of the 1st company takes his post in the front rank. When each company commander reaches the imaginary line extending behind the 1st company's left guide, he will halt, watch his own company pass, and halt it when its rear reaches this line by ordering:

- a. *— company.* b. *HALT.* c. *FRONT.*
- d. *Left-DRESS.* e. *FRONT.*

At "c. FRONT," the left guide automatically moves into the front rank and behind the left guide of the 1st company; file closers close to one pace behind the rear rank, the column being closed. After dressing his company, each commander moves to its front center. By specifying "On the 1st company, left in front," the 1st company stands fast, the others moving in front of it, the 4th company taking the lead of the column; the company commanders continue to march with their companies halting them so that the right guides may be aligned (facing toward the rear), the column being formed *left in front*.

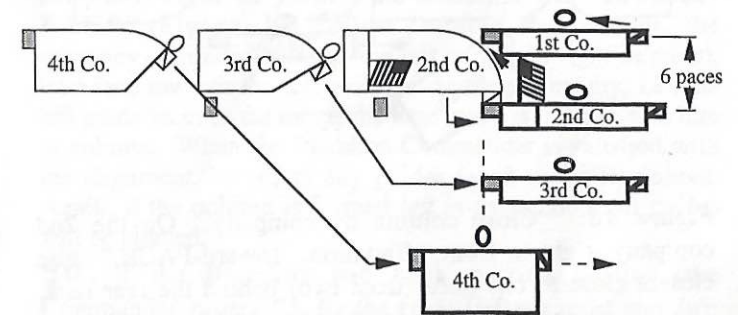

Figure 17: "Close column by company. On the 1st company right in front," from a line of battle. There is a six-pace interval between the respective company guides. File closers close to one pace (from two) behind the rear rank, the column being at less than full distance.

¹³ Hardee, William J., *Rifle and Light Infantry Tactics*, Vol. II, 1861, Para. 104.
Casey, Silas, *Infantry Tactics*, Vol. II, 1862, Para. 134.

Closing and Opening a Column

To Close

52. To close a column of companies from *full* to *half distance*, the Battalion Commander may order:

1. To half distance, close column.
2. MARCH.

(Figure 19) At "*column*," the leading company commander cautions his company to stand fast. At "**MARCH**," repeated¹⁴ by the company commanders, the other companies move forward. When each arrives at *half* (platoon) *distance* behind the company in front of it, it will halt, and dress left (if the column is *right in front*). File closers will close to one pace behind the rear rank.

53. Had the Battalion been marching (at *quick time*), the Battalion Commander orders, "**2. Double quick, MARCH**," the companies returning to *quick time* when each reaches *half distance*. The 1st company will remain at *quick time*.

54. To close on the *last* company from a halt:

1. On the (4th) company, to half distance close column.
2. Battalion. About-FACE.
3. Column forward.
4. Guide right.
5. MARCH.

(Figure 20) The rearmost company stands fast. The others face about and close on the rear company, their commanders moving outside the directing flank to see when the proper (*half*) distance is reached. After each company halts, it faces about, except its left guide who remains faced to the rear so that he may dress on the guide(s) already in place. Each company (now facing front) dresses on its left guide (facing rear). The guides remain faced to the rear until all the companies have completed the movement, and the Battalion Commander is satisfied with the alignment. He then orders:

Guides. About - FACE.

If the column is to *close in mass* (six-pace intervals between company guides), the first command will instead be: "**On the (4th) company, close in mass.**" In either case, file closers will close to one pace behind the rear rank.

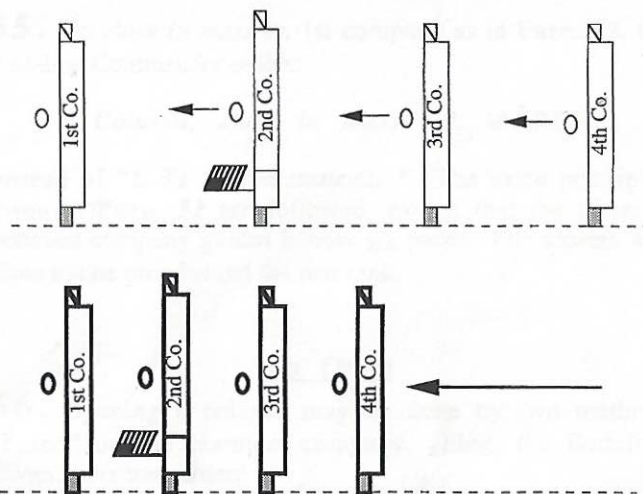

Figure 19: "To half distance, close column." The 1st company stands fast, while each of the others closes to half wheeling (company) distance on the company in front of it.

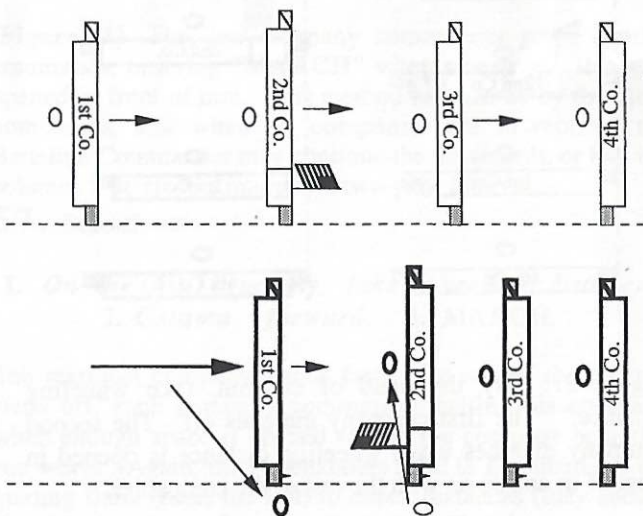

Figure 20: "On the 4th company, to half distance..." The 4th company stands fast while the others face about. The company commanders must go outside of the directing flank to see when their companies have reached "half distance." When each company halts, it faces front, and dresses on its guide, who continues to face towards the 4th company's guide until the Commander orders the guides about.

¹⁴ See Notes "On Repeating Commands," pg. 68.

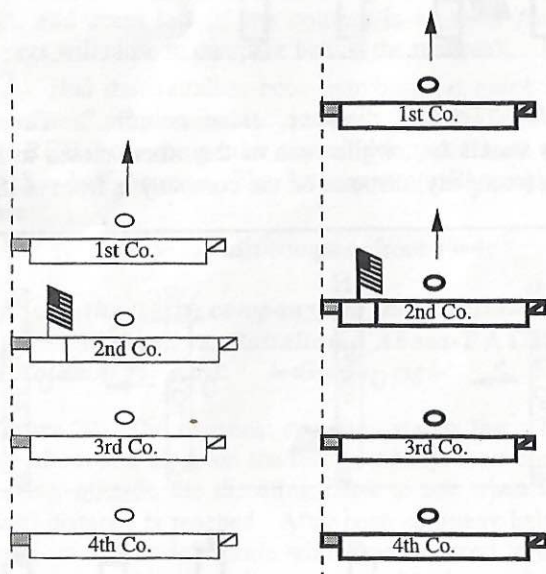

Figure 21: "By the head of column, take wheeling distance." The first company marches off. The second company marches when wheeling distance is opened in front of it; and so on with the rest of the companies.

55. To close in mass on 1st company as in Para. 52, the Battalion Commander orders:

1. Column, close in mass. 2. MARCH.

instead of "1. To half distance..." The same principles given in Para. 52 are followed, except that the distance between company guides is now six paces. File closers will close to one pace behind the rear rank.

To Open

56. Opening a column may be done by two methods "based" on the rearmost company. First, the Battalion Commander may order:

- By the head of column, take wheeling distance.*

The leading company commander then orders:

- a. First company, forward. b. Guide left.
- c. MARCH.

(Figure 21) The 2nd company commander gives similar commands, ordering "MARCH" when wheeling distance is opened in front of him. This method is repeated by the other companies, and when all companies are in motion, the Battalion Commander may continue the movement, or halt the column. File closers return to a two-pace interval.

57. Second:

1. On the (4th) company, take wheeling distance.
2. Column, forward. 3. MARCH.

The rearmost company stands fast. The rest of the column steps off, each company commander halting his company when enough space is opened so that the company behind it can wheel. Again, the commanders need to go outside of the guiding flank (here, the left) to check distances (they should therefore have a good eye for distances). File closers return to a two-pace interval.

58. Such procedures may also be used for columns by division. There are other variations to open and close, but the simplest methods are found in Paras. 52, 55 and 56.

Maneuvering a Column

At Full Distance

59. To move forward in a *column of companies* (divisions) at *full distance*, *right in front*, the Battalion Commander orders:

1. *Column, forward.*
2. *Guide left.*
3. MARCH.

At "MARCH," repeated instantly by the company commanders,¹⁵ the column steps off, the left guide of each company following in the trace of the preceding guide, maintaining *wheeling distance* (company distance); the Field Officers are to make corrections as needed. When moving *right in front*, the guide is generally to the left to best enable the Battalion to reform line to the left (**Para. 80**).¹⁶ The "leading guide" is understood to be the company guide of the leading company. The *general guides* remain in the line of file closers, unless needed to guide the company guides, especially in columns of more than one battalion, or when marking a new line of battle while the column is moving.¹⁷

60. To march to the rear without halting, the Battalion Commander orders:

1. *Battalion, right about.*
2. MARCH.
3. *Guide right.*

The column will face about and continue marching, the left and right guides moving into the rear-now-front rank, each company commander remaining in front (now-rear) of his company; the file closers remain in the rear (now-front).

61. To change the direction of the column, the Commander establishes a *marker*¹⁸ where the companies are to begin their wheels, on the outside flank of the column (on the side opposite the change of direction), and then orders:

Head of column to the right (left).

¹⁵ See Notes "On Repeating Commands," pg. 68. In general, the **ONLY** commands repeated by company commanders are "HALT" and "MARCH," and only in a column.

¹⁶ When moving *left in front* (1st company in rear), the guide is generally to the right, the right guides - "1st Sergets." - following each other.

¹⁷ See Hardee, Vol. II, Paras. 175-92.

¹⁸ See Notes "On Markers," pg. 69.

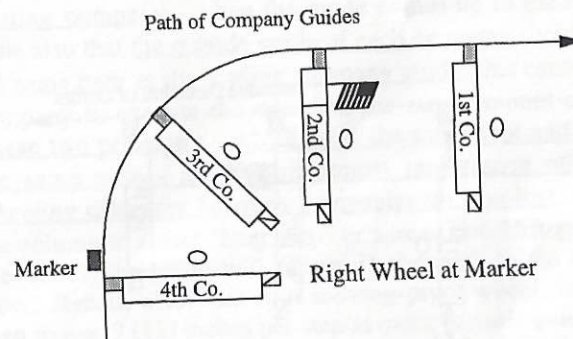

Figure 22: "Head of column to the right." The guide is left since the companies are to wheel to the right. Each company starts its wheel when its guide reaches the marker, and its guide follows the path of the guide in front of him. Following these two principles, each company wheels in the same amount of time, and distance between companies is preserved. The marker is placed on the outside (guide side) of the wheel. If the command is "Head of column to the left," the marker is placed on the right side, and the guide is shifted to the right. Note, also, that this is a moving-pivot wheel - the pivot point must be cleared for the next company.

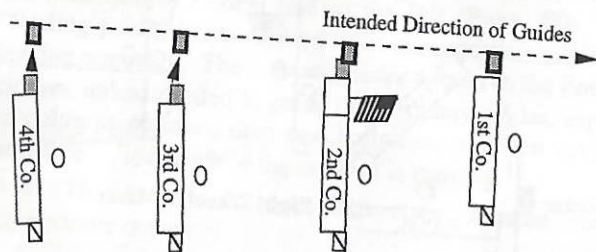

Figure 23: "Guides-COVER." The first two guides are placed, and then the other guides cover them - fall in behind them at the proper distances. The Battalion Commander then orders the Battalion to "Left-Dress," and the Battalion is realigned.

(Figure 22) If necessary, the leading company (and the others) will change its guide to the opposite side of the change of direction (e.g., guide right to wheel left), and when it approaches the marker, its company commander orders:

- a. 1st company. b. Right (Left) wheel.
- c. MARCH.

If no marker is available, the Battalion Commander will order "MARCH" when he desires the leading company to wheel, but a marker is highly recommended to set the wheeling point for the rest of the column. The other companies, their guides on the outside of the wheel, wheel at the same spot as the leading company - when the guide comes up to the marker. Note also that the outside guide of each company should trace the same path as the leading company guide; this causes each company to execute the wheel in the same amount of time. These two principles - wheeling at the same spot and tracing the same path - are of the utmost importance otherwise wheeling distances between companies will be lost, causing the column to either "bunch up" or spread out. After making the wheel, the guide will return, if changed, to the original side. Recall, also, that in a moving-pivot wheel, the pivot man moves 9 (11) inches per step at *quick (double quick) time*. The "pivot" needs to be cleared for the next company.

62. To halt:

1. Column. 2. HALT.

"HALT" being quickly repeated by the company commanders.

63. If the Battalion Commander wishes to insure the companies' left (or right) guides are on line and at the proper distances (this is important if the column is to be deployed into line), he moves in front of the column, and directs the first two company guides onto the desired line of direction. He will then command:

Guides, cover.

(Figure 23) and the other left guides cover the first two at the proper distances. The Commander next orders:

Left - DRESS.

Each company commander moves outside his guide, making sure his company dresses parallelly (facing in the new direction), and when it has, orders "FRONT," returning to his place in column. The column may also be dressed by calling out the Color Bearer and *general guides*, and then the company guides, and dressing the column in a similar manner as when dressing a line of battle as prescribed in **Para. 151, et. seq.**

64. If only a few guides need to be repositioned, the Commander orders:

1. *Guide(s) of ___ company(ies).*
2. *To the right (left).*

and has those companies dress on the column.

65. If the Battalion is in line of battle, and the Commander desires to wheel into column, *right in front*, and then to march to the left, he may command:

1. *Break to the right to march to the left.*
2. *By company.* 3. *Right wheel.* 4. **MARCH.**

(Figure 24) When the column is formed (Paras. 24 and 42), a marker is placed by the right guide of the 1st company. The Battalion Commander will then order:

5. *Forward.* 6. **MARCH.**

The 1st company immediately wheels left, marches ten paces to another marker, and wheels again to the left at its commander's order, the other companies following. The guide here is *right* - on the outside of the wheels.

Column at Half Distance

66. "In [the] presence of the enemy, the column will habitually be either at half distance or closed in mass."¹⁹ Note, however, that with smaller companies, *half distance* may be impracticably small.

67. To maneuver at *half distance*, the same procedures given for marching at *full distance* are used. However, when changing direction, the pivot of each wheel must be cleared quickly, thus the pivot man must move 14 (17) inches instead of 9 (11) per step for a moving pivot at (*double*) quick time.

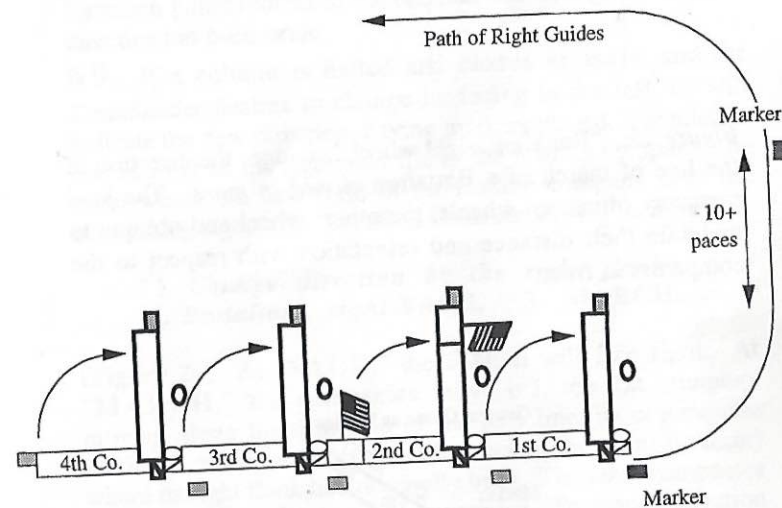

Figure 24: "Break to the right to march to left." When the column is ordered forward, the 1st company will immediately wheel left, and then again at the second marker, the others following in column.

¹⁹ Casey, Vol. II, Para. 232.

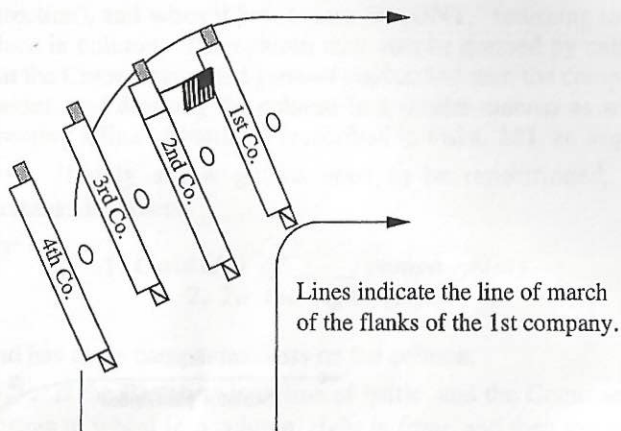

Figure 25: "Battalion, right wheel," changes the direction of the line of march of a Battalion *closed in mass*. The lead company (division) wheels, the others wheel and oblique to maintain their distance and orientation with respect to the companies in front.

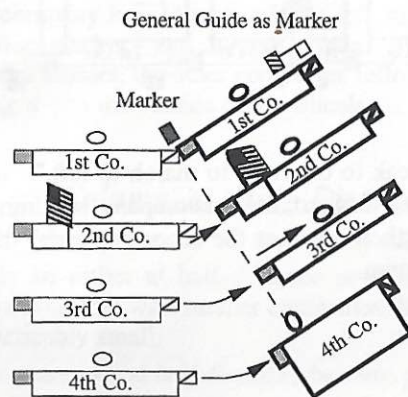

Figure 26: "Change direction by the right flank." Here, each company faces right (and doubles); the first company moves to where the new front is indicated (here we have used a marker and a general guide), the other companies moving to maintain proper distances.

Column Closed In Mass

68. To change direction when marching a column *closed in mass*, the Battalion Commander changes the guide, if necessary, and orders:

1. Battalion, right (left) wheel. 2. MARCH.

(Figure 25) The leading company will wheel as if at *half distance*, the other companies moving to conform to the wheel - sort of a mix between a wheel and an oblique - maintaining their proper distances. When the change of direction has been completed, the Commander orders the column forward. The Battalion guide returns to the original side after the change of direction has been made.

69. If a column is halted and *closed in mass*, and the Commander desires to change its facing to the left, he will indicate the new direction, having markers placed, if available: one in front of the rightmost file of the leading company, the other where the new right of the leading company is to lie, both facing right. The Battalion Commander will then order:

1. Change direction by the right flank.
2. Battalion, right-FACE. 3. MARCH.

(Figure 26) At "FACE," the column will face right. At "MARCH," the companies move off, the 1st company moving along the direction of the new line, its commander halting it when its left (last) file reaches the point (marker) where its right flank had originally been. The other companies conform to the 1st company's movement. To change direction to the right, inverse methods are used, the markers facing left, the column moving *by the left flank*.

Column of Companies to One of Divisions

70. To form a halted column of companies (at *half distance* or greater) into one of divisions, the Battalion Commander orders:

1. Form divisions.
2. Left companies, left-FACE. 3. MARCH.

At "FACE," the left (even-numbered) company of each division will face left. The right and left guides of the right (odd-numbered) company move in front of their company's right and left files, respectively, facing towards the right. At

"MARCH," each left company moves until it clears the left flank of its right company, when its company commander, who remains behind the right company's left flank, orders:

- a. — company. b. *By the right flank.*
c. MARCH. d. HALT.

(Figure 27) The left company halts at three paces before it comes into line, its left guide moving onto line with the right company's guides, facing them, in front of where one of his company's left three files will lie. The left company commander will move to the left of the right company, and order:

- e. *Right-DRESS.* f. FRONT.

Each left company then dresses on its right company, and fronts. When the divisions are formed, the Battalion Commander orders:

Guides - POSTS.

at which the company guides return to their posts, to be described in **Para. 81.** Note that the guide is now *center*.

71. Had the column been moving, left company commanders caution "*By the left flank,*" and right company commanders caution "*Mark time,*" at the Battalion Commander's preparatory command. The left guides of the right companies return to the line of file closers. When the left companies come abreast of the right companies, the Battalion Commander orders, "*Forward, MARCH*" or "*HALT.*"

72. If the column had been halted and *closed in mass,* each left company halts when it clears the left flank of its right company and fronts. Its left guide posts on the line of right company guides, its commander moves to the left of the right company, and the company then dresses up the six paces onto the right company (instead of moving by the flank).

73. Whenever divisions are formed, the senior company commander of each division posts two paces before the center of his division, the junior in the gap between the two companies. The right company's "1st Sergt." and the left company's "2nd Sergt." are the right and left guides, respectively, of each division.

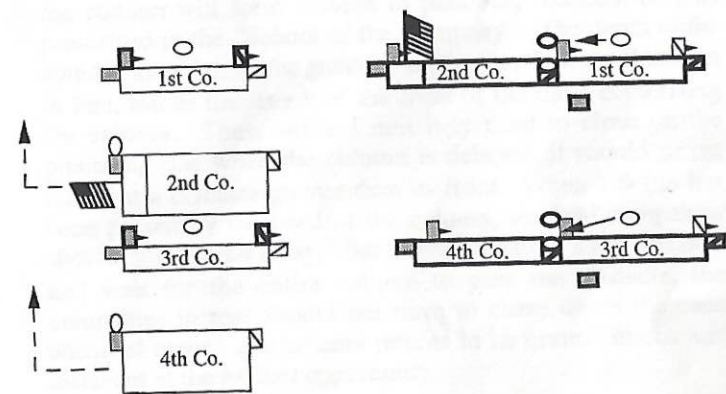

Figure 27: "Form divisions." Column of companies at half distance forming a column of divisions. The senior company commander of each division takes post in front of his division, the junior commander in the gap between the two companies. The guide is now *center*. At "Guides - POSTS," the company guides will return to their normal positions.

74. To this point, we have considered a column of companies "in maneuver." A column "in route," usually formed by company, is used when moving over moderate-to-long distances, not in the presence of the enemy. The march is at *route step*.

75. Changes of direction are made without commands, unless the change is significant, when company commanders simply caution their companies. To increase or decrease the marching rate, the Battalion Commander will direct the leading company to do so, the rest of the column following.

76. If the space narrows (*e.g.*, at a bridge or other defile), the column will form column of platoons, sections, &c., as prescribed in the "School of the Company." The depth of the column should never be greater than the length of the Battalion in line, minus the length of the front of the units comprising the column. Thus, while a unit may need to close on the preceding one when the column is delayed, it should never march at a distance greater than its front. When a defile has been passed by the head of the column, the lead companies should not "march away," but move forward a short distance and wait for the entire column to pass the obstacle; the companies in rear should not have to chase down the ones ahead of them. The column returns to its normal march and distances at the earliest opportunity.

²⁰ See also, Notes "On Route Marches by the Flank," pg. 73. While the basic principles are the same, route marches by the flank are more common.

Deploying a Column into Line

77. A column of companies may be deployed into line to the *left, right, forward* or even *faced to the rear*. Here, we still assume a column *right in front*, the guide being to the left. Ideally, each company halts three paces before it actually comes into line, automatically posts its outer guide (left guide if dressing to the right), and then its commander dresses it onto the line. The guides remain in line in front of the Battalion until posted by the Battalion Commander (Para. 81). Practical situations may dictate that the guides do not post in front, such as in a quick deployment near the enemy.

78. Markers²¹ (staff or enlistedmen, not necessarily *general guides*), are used to indicate a new line; they are especially necessary when the line is *oblique* to the primary direction. When the Battalion deploys from a halt, markers are first posted by the "Lieut. Colonel;" when moving, they are not, unless the Battalion is to halt. If no markers are available, the Battalion Commander should indicate the desired line with his sword, &c., to the "base" company commander; once this company is established, it should post its right and left guides in front of its end-files as markers for the other guides to align on. The phrase, "the indicated line" will mean the line on which the Battalion will form, indicated by markers or by the Commander's directions to the "base" company commander.

79. Movements where the companies arrive on line one after the other, instead of all at the same time, are termed *successive formations*. Ideally, each company halts three paces behind the line and posts its outer guide; it does not dress until its guide is assured of the direction by the "Lieut. Colonel." Also, each company should come to *Support Arms* when the company following it has dressed on the line (unless ordered to commence firing). *These two rules are general for successive formations.*

At Full Distance

80. To deploy LEFT into a halted line, whether from a halt or while moving, the Battalion Commander orders:

1. *Left into line, wheel.*
2. MARCH.

(Figure 28) At "*wheel*," the 1st (lead) company's right guide ("1st Sergt.") moves onto the line of left guides, facing

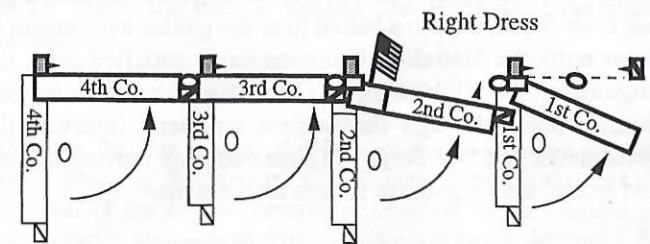

Figure 28: "Left into line, wheel." A column of companies at full distance deploying to the left into a halted line. At "wheel," the right guide of the rightmost company moves onto line with the left guides, facing them. At "MARCH," the guides halt, the leftmost man of each company faces left to the right arm of his left guide, and the companies wheel (on fixed pivots) into line.

²¹ See Notes "On Markers," pg. 69.

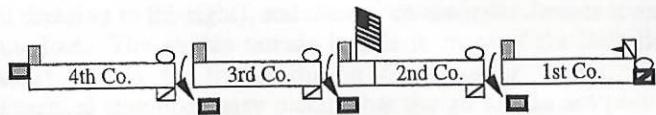

Figure 29: "Guides - POSTS." After a column of companies has been deployed into a halted line, the guides will remain in front until the Battalion Commander is satisfied with the alignment. At "Guides - POSTS," the guides return to their regular posts through the nearest company interval, the commander and "1st Sergt." of each company moving in front and rear of their rightmost files to let them pass.

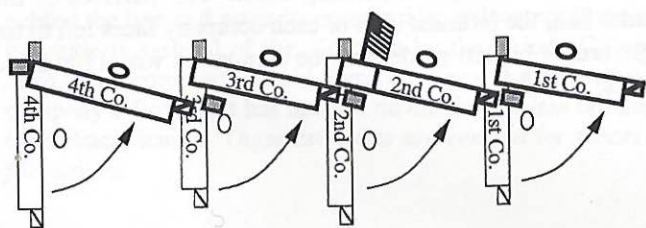

Figure 30: "By companies, left wheel" (to continue moving). The companies wheel on fixed pivots (on the leftmost front rank man, who marks time), the "2nd Sergts." moving into the line of file closers before the company flanks meet. The line then moves forward at the Battalion Commander's order (see Figure 38, Para. 100).

them, at a point near where the right three files of his company will rest. At "MARCH," quickly repeated by the company commanders, the left guide of each company halts (if moving) and the leftmost front rank man of each company faces left to the right arm of his left guide. The company then wheels (on a fixed pivot), and as it approaches the line, its commander orders it to "HALT," the commander then moves to the left of the leftmost front rank man of the company to his right, and then orders his company to:

a. *Right-DRESS.* b. **FRONT.**

The company guides remain in front until posted. Note that this movement is not a successive formation.

81. When the line is dressed, the Battalion Commander orders:

Guides - POSTS.

(Figure 29) at which, the left guides (and markers) take their posts in the line of file closers, moving through the interval of the nearest company commander, the commander temporarily stepping in front of his company's rightmost file, the "1st Sergt." stepping in rear of that file.

82. To deploy to the LEFT, and continue marching without halting, the Battalion Commander orders:

1. *By companies, left wheel.* 2. **MARCH.**

(Figure 30) At "MARCH," the left guides halt. Unlike normal "moving wheels," the wheel here has a fixed pivot so that the companies all end up on the same line after completing their wheels.²² Before the wheels are completed, each company left guide moves into the line of file closers. As the wheels near completion, the Battalion Commander orders:

3. *Forward.* 4. **MARCH.** 5. *Guide center.*

and the line of battle will march forward, as described in Para. 100. Note the difference between the two deployments: "left into line, wheel" forms a halted line, while "left wheel" forms a line that continues to move. Both are on fixed pivots.

²² See Notes "Concerning Wheels," pg. 71.

83. To deploy to the RIGHT, without markers,

1. On the right into line.
2. Battalion, guide right. 3. MARCH.

(Figure 31) At the second command, the guide of the Battalion changes from left to right, and the lead company commander cautions "Right turn." At "MARCH," the lead company turns right and will halt where the Commander indicates the new line is to rest. Assuming no markers, the lead company should then post its right and left guides (faced to the right) in front of its outer files to indicate the line for the other companies. The following companies turn in succession as each clears the left flank of the preceding company by the commands:

- a. Right turn. b. MARCH. c. Guide right.

The company then moves towards the line.

84. Ideally, however, the Battalion Commander will have the "Lieut. Col." post two markers (one may be a *general guide*, if practicable) off the right flank ahead of the column to indicate where the right file and where one of the three left files of the 1st company are to lie, the markers facing towards the new right flank. The 1st company turns at its commander's order when it comes opposite the first marker, and halts when it comes up to the markers, dressing on them (the Battalion Commander does not order "3. MARCH"). As each of the other companies approaches the line, its commander halts it three paces behind the line, its left guide moving onto the line of markers, facing them, in front of where one of his three leftmost files will rest. The commander takes his post (to the left of the leftmost front rank man of the company to the right), and assured of his guide's direction by the "Lieut. Col.," dresses his company onto the line. The company commander orders "Support Arms" when the company to the left (the next into line) has dressed. When the Battalion is properly formed, the Commander posts the guides (Para. 81).

85. If deployment to the RIGHT is urgent, the Commander will order:

1. By inversion, right into line, wheel.
2. Battalion, guide right. 3. MARCH.

(Figure 32) At "guide right," the left guide of the leading company moves onto the line of "1st Sergts." who are now guiding right. At "MARCH," the "1st Sergts." halt (if

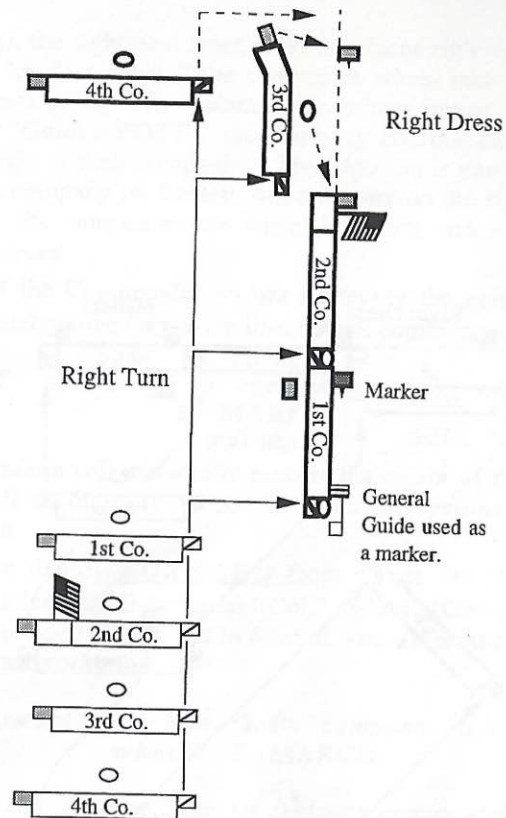

Figure 31: "On the right into line." A column of companies (here at half distance) deploying to the right. The column's guide first shifts to the right. The lead company turns right when it comes opposite the right marker, and its rightmost file guides on the right marker as it enters the line.

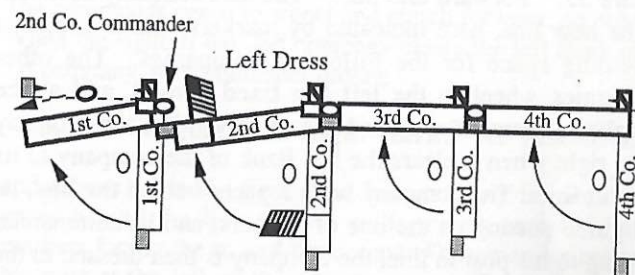

Figure 32: "By inversion, right into line." A column of companies deploying to the right by inversion. The column's guide is shifted right before the companies wheel (on fixed pivots) to the right. The companies dress on line to the left.

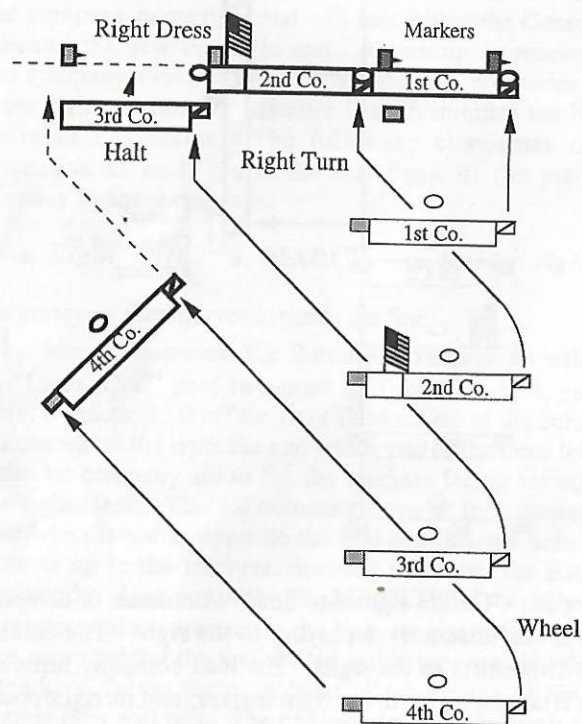

Figure 33: "Forward into line." The lead company advances to the new line, here indicated by markers; this is useful in providing space for the following companies. The other companies wheel to the left (on fixed pivots), and at the Battalion Commander's word, march forward. Each company turns right when it clears the left flank of the company to its right in line. The company halts 3 paces behind the line, its left guide posting on the line of markers, and its commander moving to his post in line; the company is then dressed to the right.

moving), the rightmost front rank man faces right to the left arm of his "1st Sergt.," the companies wheel into line, and then dress to the left, executing the mirror image of **Para. 80**. At "**Guides-POST**," the company commanders return to the right of their companies. The Battalion is now inverted (the 1st company on the left, 4th company on the right). To get out, the companies can wheel left back into a column, *right in front*.

86. If the Commander wishes to deploy the column and immediately move forward in line, he will command, instead:

1. *By inversion, by companies, right wheel.*
2. **MARCH.**

The Battalion will essentially execute the mirror of **Para. 82**. This will be the only section in which *inversions* will be discussed.

87. To deploy **FORWARD** from a halt, the Battalion Commander has the "Lieut. Col." establish markers, if available, faced to the right in front of where the 1st company will lie, and command:

1. *Forward into line.*
2. *By company, left half wheel.*
3. **MARCH.**

(**Figure 33**) At "**line**," the 1st company commander orders "**Guide right**" and advances (if necessary) his company to the new line indicated by the Commander, dressing up to the right elbows of the markers. At "**MARCH**," quickly repeated by the company commanders, the remaining companies wheel on fixed pivots until ordered by the Battalion Commander:

4. *Forward.*
5. **MARCH.**
6. *Guide right.*

The companies cease to wheel and march forward, *en echelon*. When the right of the 2nd company clears the left flank of the 1st company, its commander orders:

- a. *2nd company.*
- b. *Right turn.*
- c. **MARCH.**

and moves up to the line. The 2nd company is halted three paces behind the line, its left guide moves onto the line of markers facing them, and the company commander moves to his post at the left of the 1st company. The 2nd company, assured of its guide's position by the "Lieut. Col.," then dresses on the 1st company. The other companies move onto line in the same manner. When all the companies are in line and at *Support Arms*, the guides are posted (**Para. 81**).

88. If the Battalion had been moving, the 1st company continues forward at quick time, the others *double quicking* into line, unless the Commander causes the 1st company to halt immediately by placing markers; markers are not placed if the line is to continue to move. If the Battalion continues forward, each left guide returns to the line of file closers as his company moves onto the moving Battalion line, the leftmost left guide remaining in the front rank, the left wing company commanders shifting to the left of their companies (**Para. 100**).

89. To deploy a column *faced to the REAR*:

1. Into line, faced to the rear.
2. Battalion, right - FACE. 3. MARCH.

At "to the rear," the 1st company commander orders:

- a. 1st company, right-FACE.
- b. Forward, by file left. c. MARCH.

(Figure 34) and marches his company three paces past the indicated line, and file left. The company halts when it reaches the right of the new line, fronts, and dresses on the markers. Meanwhile, at the Battalion Commander's order "FACE," the rest of the Battalion faces right. At "3. MARCH," the companies start off, the left guide of the 2nd company moving to where the left of his company will be in the new line, facing the markers. The 2nd company files around its guide, and dresses on the 1st company. Each left guide hastens to the line, arriving there 12-15 paces ahead of his company, which will maneuver into line as prescribed for the 2nd company. If the maneuver be done at the *double quick*, all the left guides immediately go to the line at a run.

At Half Distance

90. To deploy *LEFT*, the Battalion Commander opens the column to *full distance* and deploys it as in **Para. 80 or 82**.

91. However, if the Battalion needs to form line to the left immediately, the Commander will order:

1. By the rear of column, left into line, wheel.
2. MARCH.

(Figure 35) At "wheel," the *right general guide* will run out and post on the line of left guides, just beyond where the Battalion's right will lie. The commander of the last company

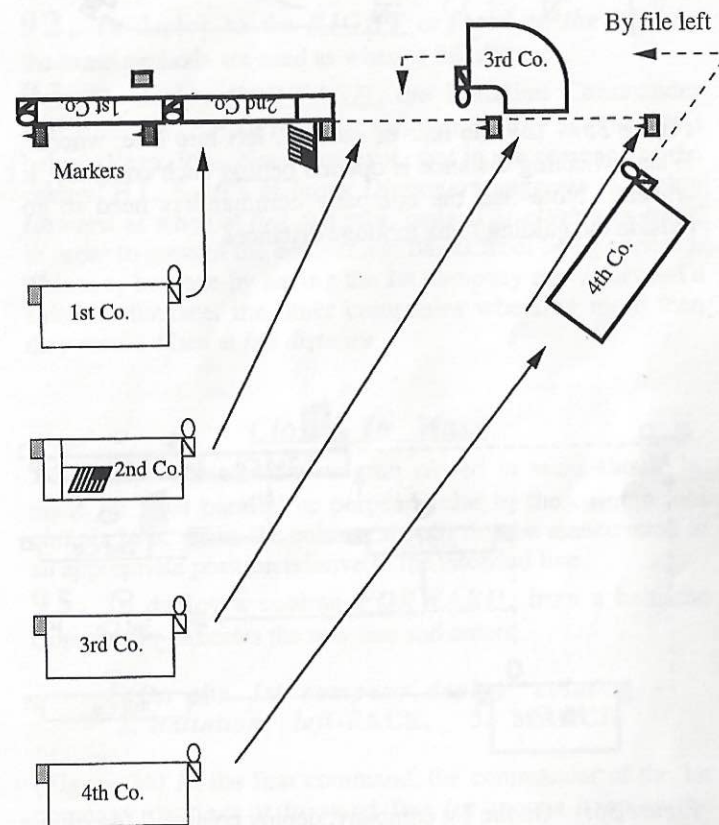

Figure 34: "Into line, faced to the rear." Note that the left guide of each company must reach the new line before the company does. Again, markers indicate the new line.

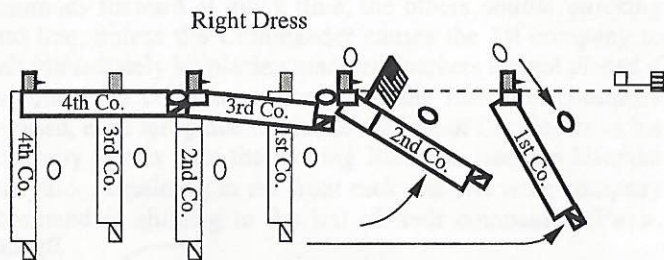

Figure 35: "By the rear of column, left into line, wheel." When wheeling distance is opened behind each company, it wheels. Note that the company commanders need to go outside the guiding flank to judge distances.

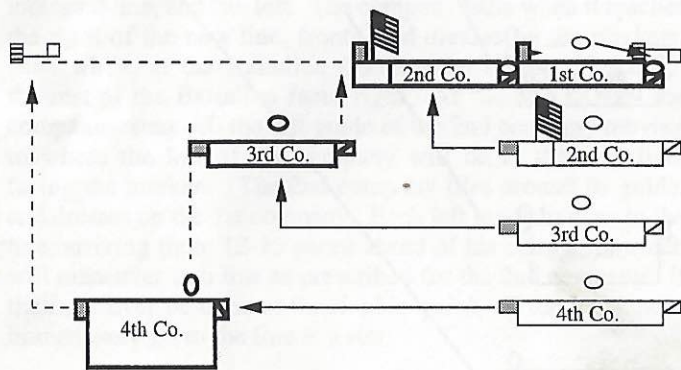

Figure 36: "On the 1st company, deploy column." A column of companies *closed in mass*, deploying forward. The 1st company stands fast (or advances to the indicated line). Each of the other companies moves by the left flank until it clears the left flank of the company to its right. It then halts, fronts, and moves towards the line. As each approaches the line, it halts and its left guide posts on the line of markers, facing them. The company commander moves to the near flank of the company that preceded his onto line, and dresses his company towards the "base" company; here, the companies dress to the right.

cautions "*Left into line, wheel,*" which is executed at "**2. MARCH.**" The preceding companies (continue to) march forward. At the moment enough distance has been opened for the last company to wheel without obstruction, the company preceding it (here the 3rd) wheels on its commander's order, and then halts and dresses onto line as in **Para. 80.** The same principles are followed by the remaining companies. Each commander must move outside the flank to judge when he has gained wheeling distance from the company to his rear.

92. To deploy to the **RIGHT** or **faced to the REAR**, the same methods are used as when at full distance.

93. To deploy **FORWARD**, the Battalion Commander will close the column *in mass*, and then deploy as prescribed below (**Para. 95**). Note, however, that in the presence of the enemy, H.L. Scott's *Military Dictionary* suggests to deploy *forward* as when at *full distance*, instead of *closing in mass*, in order to prevent the companies' flanks from being exposed. This may be done by having the 1st company move forward a suitable distance, the other companies wheeling more than they would when at *full distance*.

Closed In Mass

94. Deployments of a column *closed in mass* should be made on lines parallel or perpendicular to the column, not *oblique* to it. Thus the column should first be maneuvered to an appropriate position relative to the intended line.

95. To deploy a column **FORWARD**, from a halt, the Commander indicates the new line and orders:

1. *On the 1st company, deploy column.*
2. *Battalion, left-FACE.* 3. **MARCH.**

(Figure 36) At the first command, the commander of the 1st company cautions it to stand fast (or moves it up to the indicated line). At "**FACE,**" the other company commanders move to the left of their companies, and the *left general guide* is placed where the left of the line will rest. At "**MARCH,**" all but the 1st company marches off. The commander of the 2nd company will not move, but when his company clears the left flank of the 1st, he orders:

- a. *2nd company* b. **HALT.** c. **FRONT.**

and then he moves to his post in line of battle, his left guide moving onto the line of markers, facing them. The company

will then "**Right-DRESS.**" When the commander of each of the other companies reaches the left of the company to his right in line, he halts, letting his company pass. He will then halt the company and front it, and moving to its front, orders:

- d. *___ company, forward.* e. *Guide right.*
- f. **MARCH.**

moving it onto line as prescribed for *successive formations*. The guides are posted when the whole line is dressed.

96. The Battalion may deploy **FORWARD** on any other company, for example, the 4th company. The Commander shall indicate the position of the line (markers face to the left when placed in front of a *left wing* company), and order:

- 1. *On the 4th company, deploy column.*
- 2. *Battalion, right-FACE.* 3. **MARCH.**

(**Figure 37**) At the first command, the 4th company commander cautions it to stand fast. At "**FACE,**" the *right general guide* posts at a point outside of where the right flank is to lie, and the Battalion (except the 4th company) faces to the right. At the Battalion order, "**MARCH,**" the companies move by the right flank. The 4th company commander then orders:

- a. *4th company, forward.* b. *Guide left.*
- c. **MARCH.**

ordering "**c. MARCH**" when his front is cleared. The 4th company then advances to the indicated line, dressing to the left. The commander of the 3rd company will watch his company unmask the 4th, and then orders:

- a. *3rd company* b. **HALT.** c. **FRONT.**
- d. *Forward.* e. *Guide left.* f. **MARCH.**

The 3rd company advances towards the new line, halting three paces in rear of it. The 3rd company commander then moves to the right of the 4th company (when the 4th is on line), and his right guide moves onto the line of markers, facing them. The 3rd company will then "**Left-DRESS.**" When the commander of each of the other companies reaches the right of the company to his left in line, he halts, letting his company unmask the one to the left. He will then halt his company and front it, and move it onto line as prescribed for the 3rd company. When the Battalion Commander is satisfied with the alignment, he orders "**Guides-POSTS,**" and the guides

and company commanders return to their places in line of battle (*i.e.*, the company commanders return to the right of their companies).

97. To deploy **FORWARD** on 1st company while marching at *quick time*, the Battalion Commander substitutes: "**By the left (right) flank**" for "**Left (right)-FACE.**" The lead company continues at *quick time* while the others go to *double quick*. Instead of halting and fronting, the companies will move by the flank (undoubling) and guide onto the moving line, returning to *quick time* (**Para. 100**). If deploying on the rearmost company, that company must halt to let its front be cleared before moving forward. Markers are not placed if the Battalion is to continue marching forward in line.

98. The column may be deployed on one of the inner companies, in which case, the Battalion Commander will order "**outwards-FACE,**" or "**by the right and left flanks**" if moving.

99. Deploying a column of companies, *closed in mass*, on the **RIGHT**, or **LEFT** is as prescribed for a column at half distance. However, a *column of divisions, closed in mass*, should first change front by the left or right flanks (**Para. 69**) and then deploy forward. Note that except when deploying to the right or left from a column *closed in mass*, all of the above methods (**Paras. 77-98**) may also be used to deploy a *column of divisions*, right or left in front.

Review: General Procedures for

Successive Formations in the Field[†]

1. the Battalion Commander has *markers* posted on the intended line of battle by the "Lieut. Colonel" (assisted by the Adjutant). If the *markers* are to be in front of a *right wing* company, they face to the right; if in front of a *left wing* company, they face to the left;
2. at the preparatory command (e.g., "*Forward into line*") the "base" company forms on the markers;
3. the other companies are then set in motion (e.g., "*By company, left half wheel. MARCH. ...*"), and march to the line, arriving in the following order: from the company(ies) next to the "base" company, to the one(s) furthest away in line of battle;
4. as it approaches the line, each company halts 3 paces in rear of its place in line;
5. when each company halts, the company guide furthest from the markers - the "outer guide" - posts on their line, facing them; the guide posts in front of where one of the company's 3 outer files will lie. The "Lieut. Colonel" will insure that each guide posts on the line of markers, correcting the guide's position if necessary;
6. at the same time, the "Captain" (company commander) moves to the side of the front rank man of the company that preceded his into line - the "Captain" posts on the side of his company in the direction that the company is to dress;
7. the "Captain" dresses his company towards the "base company," up to the near elbow of his company guide, not ordering "*Right (Left) - DRESS*" until assured that his guide is on the line by the "Lieut. Colonel;"
8. each company comes to *Support Arms* when the company that follows it has dressed onto the line (unless ordered to fire). The last company will *Support Arms* as soon as it dresses;
9. at the Battalion Commander's order, "*Guides-POSTS,*" the guides and markers return to their places in line through the nearest company interval, made by the "Captains" and "1st Sergts." moving, respectively, in front of and in rear of, their rightmost file; "Captains" that dressed their companies to the left return to the right of their companies.

[†] e.g., from a column of companies: *Forward into line, On the right into line*, and deployments from a closed column, &c.

If the battalion is to immediately fire, these procedures are, by necessity, not followed. The base company fires by file when the company next to it has reached the line.

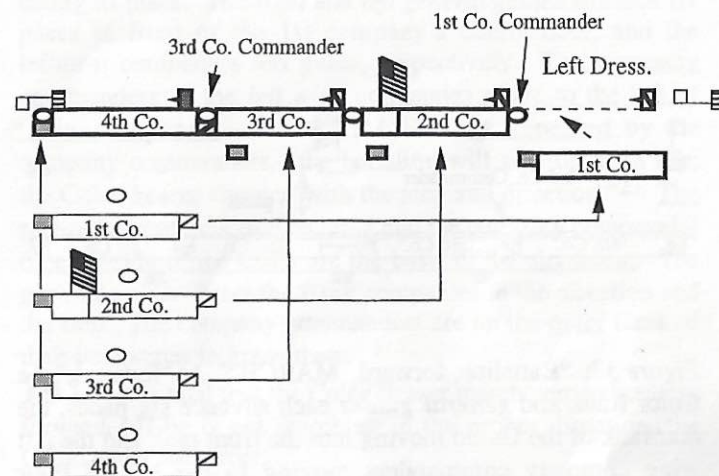

Figure 37: "On the 4th company, deploy column." A column of companies *closed in mass*, deploying forward. Each company moves by the right flank until it clears the right flank of the company to its left. It then halts, fronts and moves towards the line. The 4th company simply advances to the indicated line, dressing to the left. When each of the other companies approaches the line, it halts and its right guide posts on the line of markers, facing them. The company commander moves to the near flank of the company that preceded his onto line, and dresses his company towards the "base" company; here, the companies dress to the left.

Maneuvering in Line

100. The Battalion being in line, and the Battalion Commander wishing to advance, he will command:

1. *Battalion, forward.* 2. **MARCH.**

(Figure 38) At "*forward*," the front rank (Color Rank) of the Color Guard advances six paces, the Guard's rear rank taking its place. The *right* and *left general guides* advance six paces in front of the 1st company's commander, and the leftmost company's left guide, respectively. The company commanders of the left wing companies move to the left of their companies. At "**MARCH**," not repeated by the company commanders, "the battalion will step off with life; the Color-bearer charged with the step and direction."²³ The rear-now-front rank of the Guard and the company commander on each side of the Color are the basis of the alignment. The *general guides* direct the flank companies in the direction and the step. The company commanders are on the outer flank of their companies to guide them.

101. It is vital that the Color Bearer march perpendicularly forward. If he is not marching in the proper direction, the Commander will order:

Point of direction to the right (left).

and indicate the correct direction to the Color Bearer. To ideally correct the movement, the "Major," under direction of the Commander, will move (ride) in front of the Color Bearer, who marches towards him. The positions of the "Lieut. Col." and "Major" in a moving line are given in **Para. 164.**

102. "If openings be formed, if the files crowd each other, if, in short, disorder ensue, the remedy ought to be applied as promptly as possible, but calmly, with few words, and as little noise as practicable."²⁴ If the step is lost, the Commander will order:

To the - STEP.

and the Battalion will look to the Color Rank or a *general guide* and retake the step.

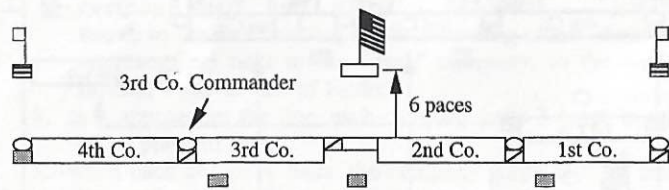

Figure 38: "Battalion, forward. MARCH." At "*forward*," the Color Rank and *general guides* each advance six paces, the rear rank of the Guard moving into the front rank and the left wing company commanders moving to the left of their companies. The rear-now-front rank of the Color Guard, and the company commander on either side of the Color, are the basis of the alignment. When the line halts, the Color Rank, *general guides* and left wing commanders remain where they are until the Battalion Commander orders: "Color and general guides-POSTS." Then, the Color Rank returns to the ranks, the *general guides* to their posts in rear, and the commanders to the right of their companies. Note, we have not included the file closer rank of the Guard.

²³ Hardee, Vol. II, Para. 597. Casey, Vol. II, Para. 659.

²⁴ Hardee, Vol. II, Para. 619. Casey, Vol. II, Para. 682.

103. The line may also move at an *oblique* with:

1. *Right (left) oblique.*
2. MARCH.

Care should be taken so that the files do not crowd. To return to the original direction, the Commander will order the Battalion *forward*.

104. To halt the line:

1. Battalion.
2. HALT.

The Color Rank and *general guides* remain in front until ordered:

Color and general guides - POSTS.

at which, the *left wing* company commanders also return to their places on the right of their companies. If necessary, the Battalion Commander will order "*Captains, rectify the alignment,*" at which the company commanders will simply dress their companies on the Color (*center*). Or, he may give a general alignment using the methods of **Paras. 151-156.**

105. To face by the rear rank, the command is:

1. Face by the rear rank.
2. Battalion.
3. About-FACE.

(Figure 39) At "*rank,*" each company commander steps out of ranks and faces about to the rightmost file of his company, the "1st Sergt." moving behind him. The file closers of each company move through their own commander's interval to a place opposite their positions in line of battle. As soon as the last file closer passes through, the Battalion Commander orders "FACE." The company commanders and the Color Bearer will move to the rear rank (now in front). In this position, the Battalion may now fire towards its rear. To return to the original facing, the Commander will preface the command with, "1. Face by the front rank."

106. To march in retreat (without facing by the rear rank), the Battalion Commander will first face it about:

1. Face to the rear.
2. Battalion, about-FACE.

(Figure 40) The line faces about, the Color Bearer moving to the rear rank. The file closers, company commanders, &c., remain where they are, but faced to the rear. The Commander will then order:

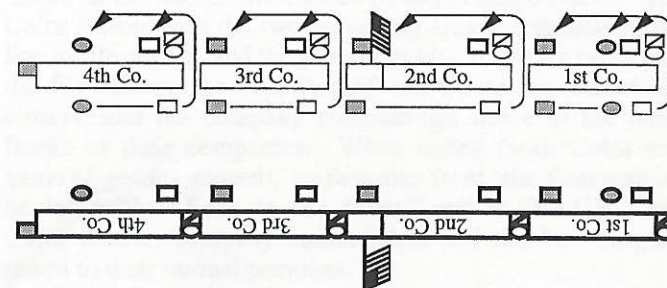

Figure 39: "Face by the rear rank." At "rank," the company commanders and "1st Sergeants" step out, and the file closers of each company pass through their commander's interval. As the last file closer passes through, the Battalion Commander orders "FACE."

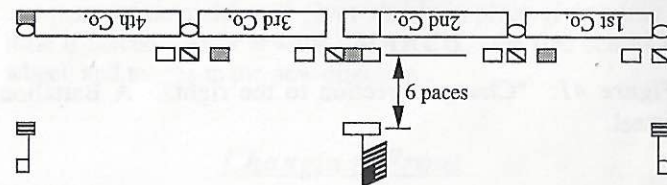

Figure 40: "Face to the rear" and marching in line. The file closers have not passed through to the other side as this is not a "face by the rear rank." The Color Bearer and two Guard corporals, and the *general guides*, move six paces past the line of file closers at "forward." Company commanders move to the outside flanks of their companies, while the "1st Sergeants" move into the line of file closers.

3. Battalion, forward. 4. MARCH.

At "*forward*," the Color Bearer and center corporal of the Guard in the line of file closers (if any) change places. The Color Bearer with the two remaining Guard corporals in the line of file closers, and the *general guides*, move six paces past the file closers, the "1st Sergts." move into the line of file closers, and the company commanders move to the outer flanks of their companies. When halted (with Color and *general guides* posted), to face the front, the Commander begins with: "*Face to the front*," and at "FACE," the Color Bearer, company commanders and the "1st Sergts." return to their normal positions.

107. While marching forward (Para. 100), the line may move to the rear and continue marching (or halt) with:

1. Battalion, right about. 2. MARCH (HALT).

108. While marching forward, if the Battalion Commander wishes to change direction to the right or left, he will order a "battalion wheel:"

1. Change direction to the right (left). 2. MARCH.

(Figure 41) Here, the Color and center of the line will shorten their steps to 14 inches (or 17 if at *double quick*). The outside company commander will continue marching at the current rate and step of 28 (33) inches, while the inside company commander will pivot *slowly* in place giving way a little if forced. At "*Forward. MARCH*," the line ceases to wheel, and moves in the new direction.

Changing Front

109. The Battalion being at a halt, and the Commander wishing to change front to the right by 90° (as if doing a right wheel), he will have markers placed to define the new front of the 1st company, and have that company wheel and move up to the markers. If there are no markers, when the 1st company moves to the indicated line, it should post its company guides in front of its end-files as markers for the other companies. The Battalion Commander will then order:

1. Change front forward on 1st company.
2. By company, right half wheel. 3. MARCH.

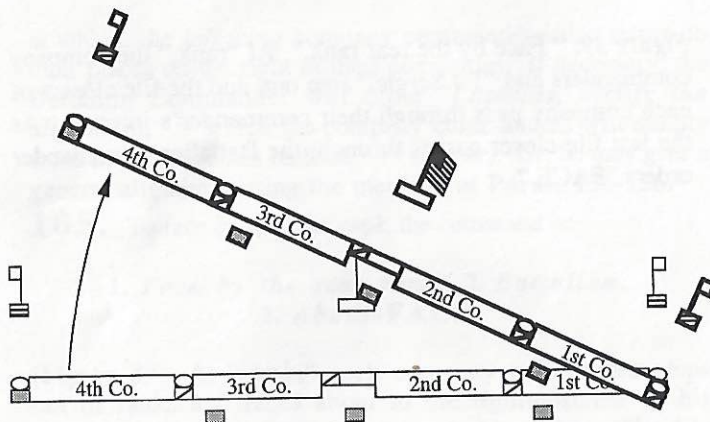

Figure 41: "Change direction to the right." A Battalion wheel.

(Figure 42) At "half wheel," the other company commanders post themselves in front of the center of their companies, cautioning them to wheel. At "MARCH," each company wheels on a fixed pivot, the left guide guiding it as soon as practicable, and when they have wheeled far enough (roughly 45°), the Battalion Commander orders:

4. Forward. 5. MARCH. 6. Guide right.

The companies will now be marching forward, *en echelon*. When the right of each company comes opposite its place in line, its commander orders, "Right turn. MARCH," and then brings it into line. This is done by halting it three paces behind the line, the left guide automatically moving onto the line of guides (facing them); the commander moves to his post in line, and dresses his company to the right. The company guides are posted when the Battalion is dressed. Note how much faster and easier this is than trying to wheel the whole Battalion. Note also, that when the companies stop wheeling and start marching forward, the movement is the same as when *deploying forward* (Para. 87).

110. If the line is moving, the Battalion Commander will give the same commands. However, the 1st company commander cautions:

a. Right turn. b. Quick time.

and waits for the Battalion Commander's "3. MARCH," when the 1st company turns and halts at the indicated line. The other companies wheel in place until "4. Forward. 5. MARCH," and deploy as described above.

111. The Commander may also wish to change front forward on the last company - 90° to the left - in which case *right* becomes *left*. The leftmost company establishes the new line; it is now the right guides that post on the line of markers, the companies dressing to the left. The Battalion ends up as if it had done a left wheel.

112. To change front to the rear on the 1st company, the Battalion Commander has the 1st company face about and move past the indicated line. Markers are then placed; the 1st company faces about again, and dresses on them. The Battalion Commander then orders:

1. Change front to the rear, on 1st company.
2. Battalion, about-FACE.
3. By company, left half wheel. 4. MARCH.

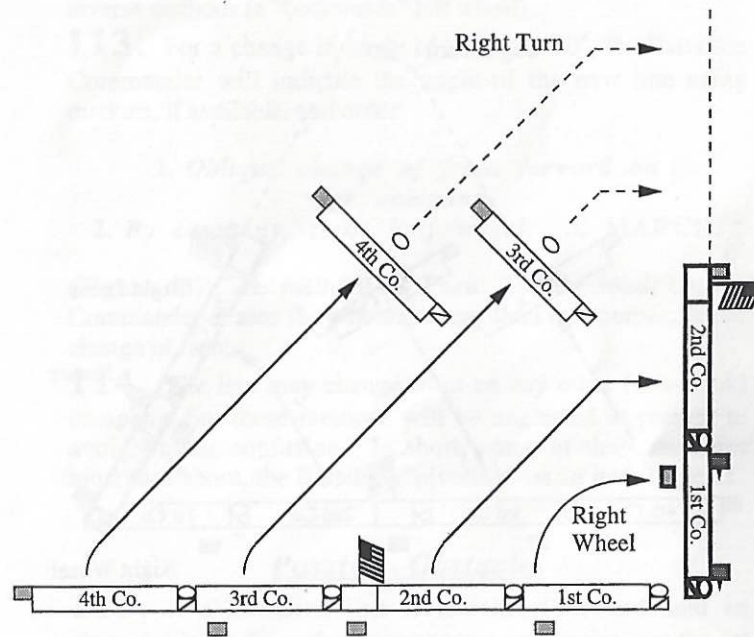

Figure 42: "Change front forward on 1st company. ..." The Battalion Commander has the 1st company wheel 90° to the right, and advance to the markers (if necessary). At "MARCH," the other companies wheel to the right on fixed pivots, and at the Battalion Commander's word, march forward. Each company turns so that it will come into its place in line, dressing to the right as in *successive formations*.

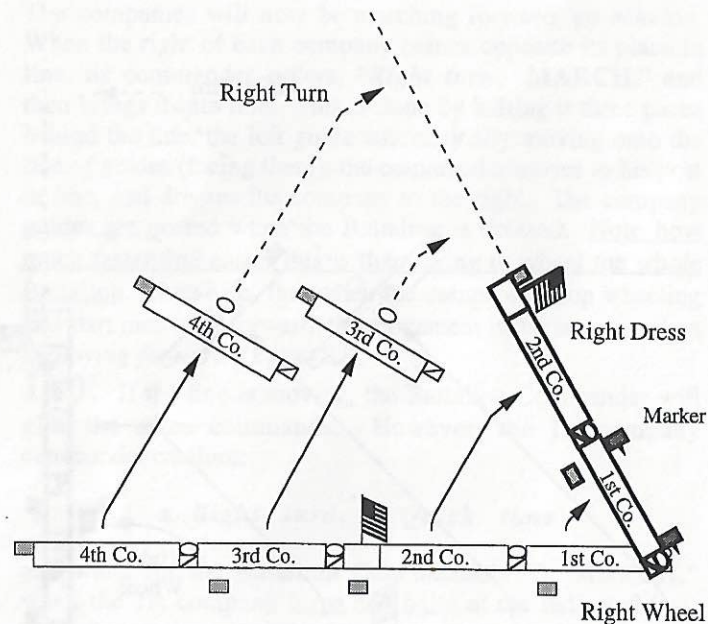

Figure 43: "Oblique change of front forward on 1st company. ..." The 1st company wheels to the right and advances (if necessary) to the indicated line. At "MARCH," the other companies wheel to the right, and at the Battalion Commander's command, march forward, each company turning so as to come into line, dressing to the right. Note that the companies do not need to wheel as far as in a full change of front.

The Battalion faces about (the file closers now in front), and basically does the mirror image of **Para. 109** (reflected about the original line of battle). Each company passes the new line by three paces, halts and faces about, and then dresses to the right in the usual manner, the guides remaining in front until posted. The Battalion will in essence have done a "backwards" right wheel. Note that this movement may be done to refuse the left wing of a Battalion, but care should be taken not to expose the men's backs to the enemy. As in the last paragraph, front can be changed on the leftmost company by inverse methods (a "backwards" left wheel).

113. For a change in angle of less than 90°, the Battalion Commander will indicate the angle of the new line using markers, if available, and order:

1. *Oblique change of front forward on 1st company.*
2. *By company, right half wheel.*
3. **MARCH.**

(Figure 43) The methods of **Para. 109** are used, but the Commander ceases the wheels sooner than in a perpendicular change of front.

114. The line may change front on any other (non-flank) company, but these methods will be neglected at present to avoid further confusion. In short, some of the companies must face about, the Battalion "pivoting" on an interior point.

Passing Obstacles

115. If a Battalion line is marching forward, and an obstacle blocks the path of one or more companies, say the 1st company, the Battalion Commander orders:

First company, obstacle.

The 1st company commander will move to the center of his company, and order:

- a. *1st company, by the left flank, to the rear into column.*
- b. *Double quick.*
- c. **MARCH.**

(Figure 44) The 1st company will move by the left flank behind the 2nd company. The 1st company commander will halt behind the right of the 2nd company, watch his own company march past, and order:

- d. *1st company.*
- e. *By the right flank.*

f. MARCH. g. Guide right.

The 1st company will then march behind the 2nd company as if in column at *full distance* (or *closed in mass*, according to Casey), returning to quick time. As this "column" is *left in front*, the 1st company guides to the right.

116. When the obstacle has been passed, the Battalion Commander orders:

1st company, forward, into line.

At which, its commander orders:

- a. *By company, right half wheel.*
- b. *Double quick.* c. MARCH. d. *Forward.*
- e. MARCH. f. *Guide left.*

When the company's left is clear to march forward, its commander orders, "*Left turn - MARCH,*" and the company moves up onto the moving line (if *per Casey*, then flanking movements are to be executed instead).

117. In general, companies displaced by obstacles move towards the center. Thus, in a battalion of, say, eight companies, two or more companies (*e.g., "Right three companies, obstacle."*) may be *in column* behind the line, with the outer ones in rear (*e.g., the 4th-8th in line from right to left, the 3rd, 2nd and 1st in column behind the 4th.*)

118. However, if the center companies need to move, they move towards the flank so that the companies in each column belong to the same wing. For example:

Two center companies, obstacle.

(Figure 45) They will return to line by deploying forward as in Para. 116.

By the Right of Companies

119. If a halted Battalion in line needs to pass through woods or a gun line, &c., an appropriate command may be:

1. *By the right of companies to the front.*
2. *Battalion, right-FACE.* 3. MARCH.
4. *Guide right.*

(Figure 46) At "*front,*" the commanders move to the front of their companies and caution them to face right. At

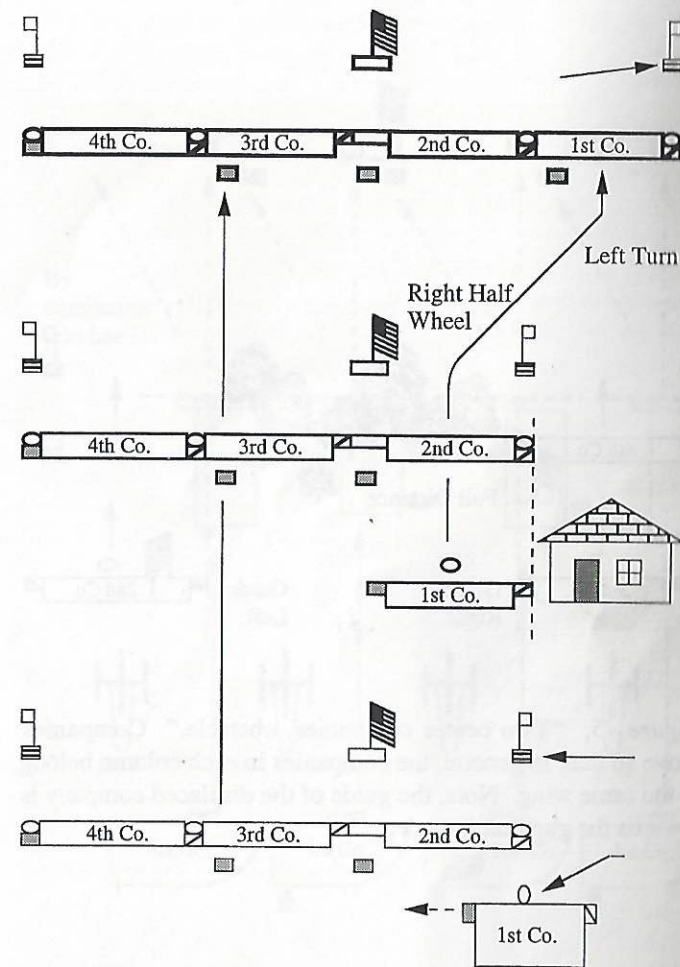

Figure 44: "1st company, obstacle." The 1st company moves by the left flank "into column" at full distance (closed column, according to Casey) behind the 2nd company. When the obstacle is passed, the Battalion Commander will order "1st company, forward into line."

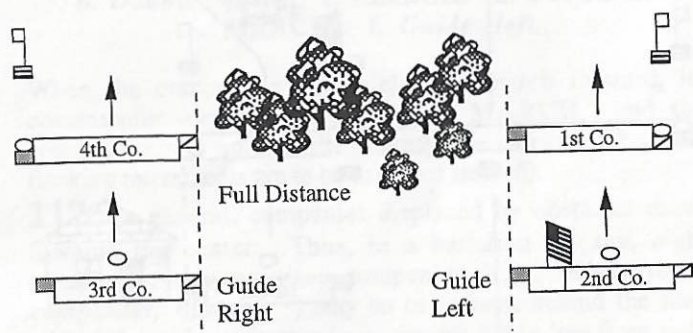

Figure 45: "Two center companies, obstacle." Companies move so that, in general, the companies in each column belong to the same wing. Note, the guide of the displaced company is towards the gap that it made.

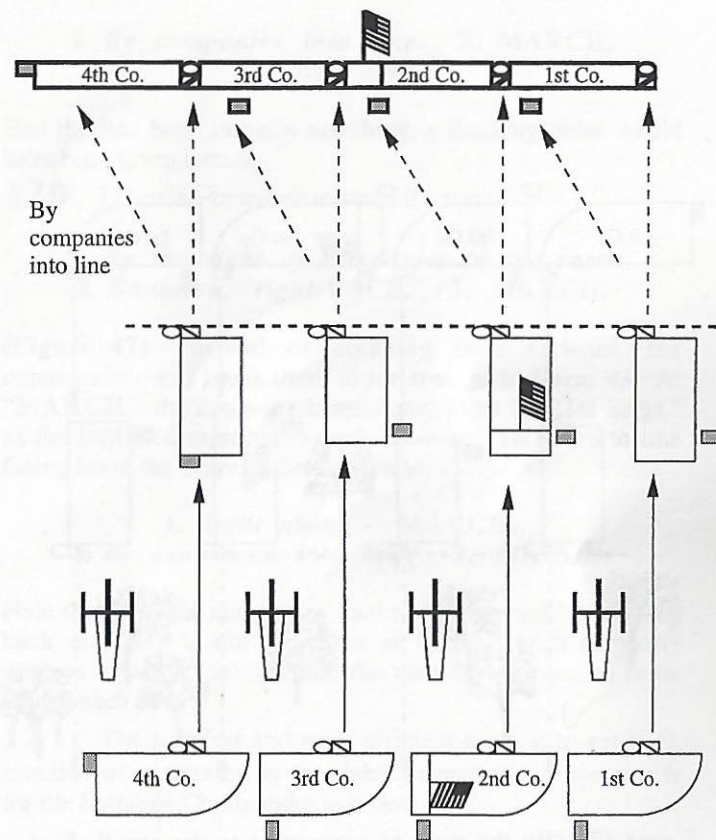

Figure 46: "By the right of companies to the front." Each company breaks files forward, and the Battalion moves off in parallel columns of four (by the flank) by company. Note that the head of each column should stay dressed on line. To deploy back into line, the Battalion Commander orders: "By companies, into line." Here, we pass through a gun line.

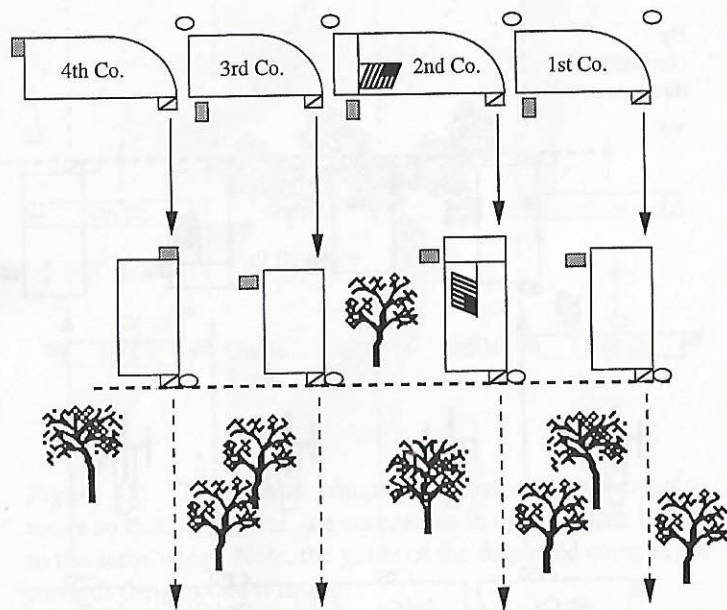

Figure 47: "By the right of companies to the rear." Each company breaks files to the rear, and the Battalion moves off in parallel columns of four by company. Here, we withdraw through a treeline.

"FACE," the commanders move to the right and break files *forward*, similarly as in **Para. 43**; the commanders post to the left of their "1st Sergts." At "MARCH," the companies march off in the direction of the Battalion front, keeping the head of each column of four dressed on line, and maintaining the proper distance between each company. When the Commander wishes to return to line of battle, he orders:

1. *By companies into line.*
2. MARCH.
3. *Guide center.*

Had the line been initially marching, a flanking order would have been given instead.

120. Likewise, to march towards the rear:

1. *By the right of companies to the rear.*
2. *Battalion, right-FACE.*
3. MARCH.

(Figure 47) Instead of breaking files forward, the commanders will break them to the rear, as in **Para. 43**. At "MARCH," the company commander joins his "1st Sergt." as the Battalion marches towards the rear. To return to line facing front, the Commander may order:

1. *Right about - MARCH.*
2. *By companies into line.*
3. MARCH.

Note that here, the companies' ranks are "inverted," and going back *into line* is not the same as normal: each company deploys towards the right and the men do not need to cross behind each other.

121. The simplest and most efficient method to get back into line when moving *by the right of companies to the rear* is for the Battalion Commander to order:

1. *By file left.*
2. MARCH.

Each company will file left behind the one on its right in line of battle. Allowing each company room, the Battalion will now be moving as if *by the right flank*.²⁵ At the Battalion Commander's "HALT" and "FRONT," the column faces left, back into a battle line, facing the original direction.

²⁵ The reader may note that such a movement is alluded to in the "School of the Company," in which a column of platoons is ordered, "*By the right flank, by file left.* MARCH" (Hardee, Vol. I, "School of the Company," Para. 314).

Column Doubled on the Center

122. At times, it may be desirable to form a column based on the center two companies. The end result is a "column of divisions" formed by two "columns of companies" deployed side-by-side, the right wing being *left in front*, the left wing being *right in front*, the Colors at the center of the leading division. The *double column* is formed either at company (half) distance, or *closed in mass*.²⁶

123. The *double column* should not be formed when several Battalions are in a Brigade column (*i.e.*, marching down the road) due to the difficulty in quickly forming a Brigade line from such a column. The *double column* is better used when the Brigade (or a single Battalion) is maneuvering in line of battle (over long distances with various obstacles), or changing the Brigade's front. In these cases, it is easier to move the Brigade line by first forming *double columns*, each Battalion being represented by its center two companies; care should be taken to ensure that proper distances between Battalions are preserved so that the line may be easily reformed. The *double column* is also useful when a Battalion is waiting in reserve, and in the passage of lines (a reserve line relieving the forward line).

Forming the Double Column

124. The Battalion, being in line of battle, is given the command:

1. *Double column, at half distance (closed in mass).*
2. *Battalion, inwards - FACE.*
3. **MARCH.**

(Figure 48) At "*half distance*," the company commanders move to the front center of their companies, the "1st Sergeants" stepping into the front rank. The two center company commanders warn their companies to stand fast; the right wing commanders warn their companies to face left; the left wing commanders warn their companies to face right. At "**FACE**," the companies execute what their respective commanders cautioned them to do (*e.g.*, right wing companies face left). The companies that face inward break files to the rear, each

²⁶ Older manuals (*e.g.*, Scott's 1815 *Rules and Regulations for the Field Exercise and Manœuvres of Infantry*), refer to this as a "Column of Attack" - it is the classical Napoleonic "column" - its short frontage allowing for easy and rapid movement over long distances, its depth making it powerful, and its wing-columns allowing rapid deployment into line, &c.

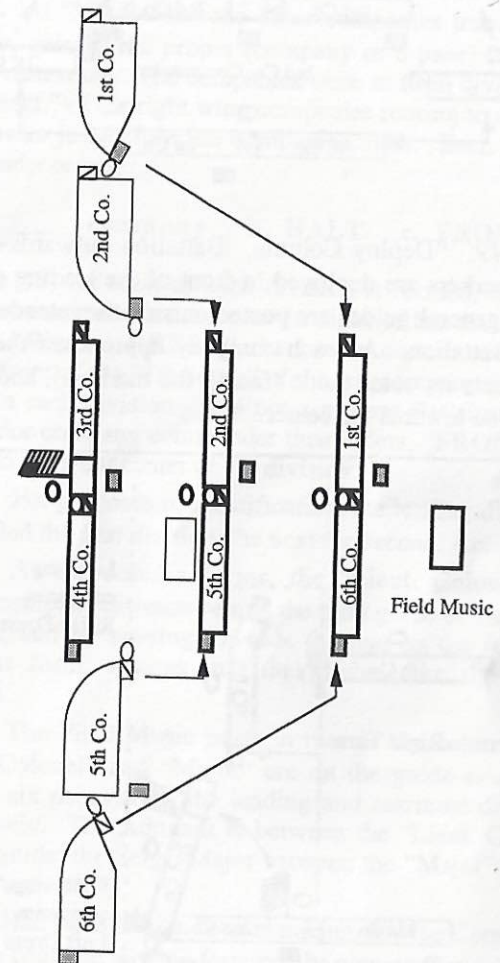

Figure 48: "Double column at half distance" (*i.e.*, company distance). The two center companies stand fast, the other companies face inward, break files to the rear, and march by the shortest path to the rear, the flank companies forming furthest in rear. For example, as shown here, in a six-company battalion, the 3rd and 4th companies stand fast, followed by the 2nd and 5th companies, with the 1st and 6th in rear. The Field Music is in rear of the column.

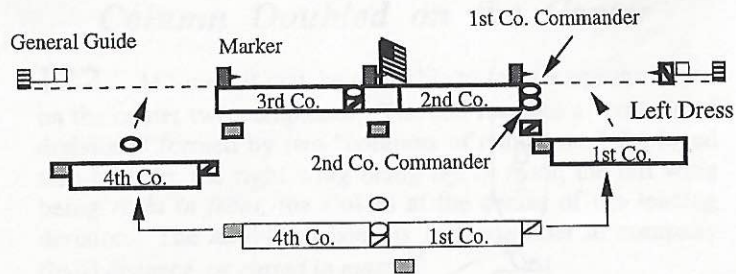

Figure 49: "Deploy Column. Battalion outwards-FACE." Three markers are deployed in front of the leading division, and the general guides are posted outside the intended flanks of the Battalion. As each company approaches the line, it halts, posts its outer guide (facing the markers), and dresses on the line towards the center.

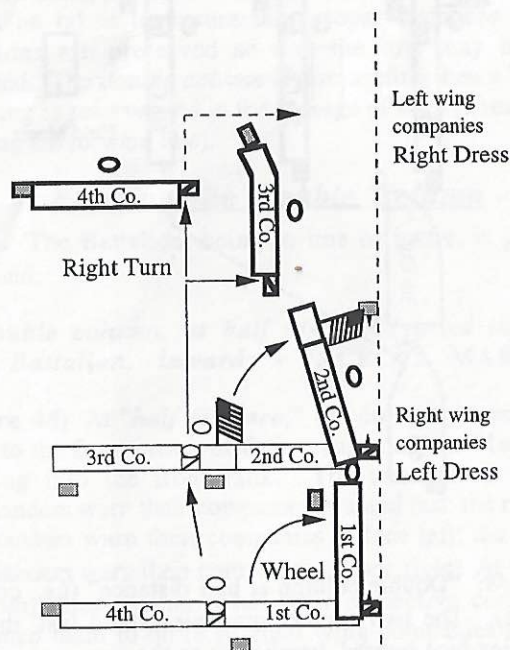

Figure 50: "Right into line wheel, left companies on the right into line. Battalion, guide right. MARCH." At "guide right," the left guide of the Color Company moves onto the line of division right guides, facing them. At "MARCH," the right wing companies wheel (fixed pivots) right into line, the left wing companies continue forward, executing "on the right into line."

company commander moving to the side of his leading guide (the left guide in each of the right wing companies moves in front of his front rank men).

125. At "MARCH," the outer companies march toward the rear, gaining the proper (company or 6-pace) interval by the shortest route. The companies unite to form divisions; the "2nd Sergt." of the right wing companies retiring to the line of file closers just before the companies meet. Each company commander orders:

a. ___ company. b. HALT. c. FRONT.

(Figure 48) As soon as each division is formed, the senior company commander moves to the right of the division, and orders, "Right - DRESS," the junior commander taking post in front of the "1st Sergt." of the left company (this dress is within each division - it is not a general Battalion guide). The senior company commander then orders, "FRONT," and moves to the front center of the division.

126. For purposes of identification, the leading division is now called the *first division*, the next the *second*, &c.

127. As the column forms, the "Lieut. Colonel" will move a company distance behind the right guide of the leading division, and by moving towards the rear as the following divisions form, assures that the guides take the correct direction.

128. The Field Music posts in rear of the column. The "Lieut. Colonel" and "Major" are on the guide-side of the column, six paces from the leading and rearmost divisions, respectively. The Adjutant is between the "Lieut. Colonel" and the guide; the Sergt. Major between the "Major" and the guide (Para. 167).

129. Had the Battalion been marching, and the Commander wishes to continue moving forward, the command would be:

1. Double column at half distance.
2. Battalion, by the right and left flanks.
3. (Double quick-) MARCH.

At "MARCH," the Color and general guides return to the their places in ranks. The center two companies continue to march forward at *quick time*, while the other companies fall in behind. As the companies unite at the center, each company commander orders:

- a. _____ company, by the right (left) flank.
- b. MARCH.

The senior company commander of each division takes command of it, and orders it to "Guide right."

130. A column doubled on the center maneuvers, and opens and closes its distances, as a standard column of divisions. The *double column* generally guides to the right, but sometimes guides left or center. The Color Rank does not advance when the column maneuvers.

131. With an odd number of companies, the odd company posts in rear of its own wing (generally the left).

Deploying the Double Column Forward

132. To deploy from a halt, the Battalion Commander posts three markers in front of the leading division - before its right and left files, and the left file of the right company - and then has the *general guides* post just outside of the Battalion's flanks when in line. The Commander then orders:

1. Deploy column. 2. Battalion outwards - FACE. 3. (Double quick-) MARCH.

(Figure 49) The leading division stands fast, while the others face outward and deploy as when deploying a column closed in mass.²⁷ Each company *Supports Arms* when the company that enters the line after it has dressed on the line. When the Battalion is dressed, its Commander orders:

Guides - POSTS.

If the Commander desires firing to commence immediately, he instructs the center companies, who *fire by file* as soon as the companies next to them have come onto line, &c; the guides will automatically post in the line of file closers.

133. If the double column is moving, and the Commander wishes to deploy into a halted line, he posts three markers ahead of the leading division, and when near the markers, orders:

²⁷ A quicker method of deploying the column is to deploy *forward into line* (Para. 87), the companies executing "*right and left half wheel*," instead of flanking movements.

1. Deploy column. 2. Battalion by the right and left flanks. 3. (Double quick-) MARCH.

The Battalion then deploys on the markers.

134. If the Battalion is to continue marching, no markers are placed, and the same commands as in Para. 133 are given. At "Deploy column," the lead division commander cautions "*Quick time*." At "3. Double quick - MARCH," the Battalion Commander also orders "*Guide center*," at which, the Color Rank advances six paces (since the Battalion is forming a moving line), and the commanders of the leading companies move to the outer flanks of their companies. The other companies move by the flanks at the *double quick* and guide onto the moving line (Para. 100). When moving, it may be more efficient to deploy *forward into line*.

Deploying to the Right or Left

135. If the Battalion is to form on the right or left, a "composite" command is required, since the right wing is *left in front*, and the left wing is *right in front*.

136. To deploy a halted column to the RIGHT, the command is:

1. Right into line wheel, left companies on the right into line. 2. Battalion, guide right. 3. (Double quick-) MARCH.

(Figure 50) At "*on the right into line*," the company commanders move in front of their companies, right wing commanders cautioning their companies to right wheel, left wing commanders cautioning theirs to move forward. At "*guide right*," the *left guide* of the Color Company, under the supervision of the "Lieut. Colonel," posts facing the line of division *right guides* at a spot where one of the left three files of his company will lie when it wheels to the right into line.

137. At "MARCH," quickly repeated by the company commanders, the right wing companies wheel right (on fixed pivots) into line (the mirror image of Para. 80), while the left companies march forward, deploying *on the right into line* when they clear the right wing's left flank (Paras. 83, 84).

138. If the Battalion is moving, the Commander orders:²⁸

1. *Right into line wheel.*
2. *Left companies on the right into line.*
3. *Battalion, guide right.*
4. *(Double quick-) MARCH.*

At the first command, the commanders move to the front of their companies, cautioning them either to wheel, or to form *on the right into line*. At "MARCH," repeated by the commanders, the companies form a halted line as above.

139. If the Battalion is to move forward in line without halting, the Commander also orders:

5. *Forward.*
6. *MARCH.*

when the right wing companies complete their fixed-pivot wheels. At "*Forward*," the right wing commanders caution, "*Quick time*;" at "6. MARCH," the right wing companies move forward. The Battalion Commander then orders:

7. *Guide Center.*

the Color Rank and *right general guide* moving forward six paces. The left wing companies move at the *double quick* to catch the right wing.

140. If the Battalion is to deploy to the *LEFT*, the commands are the same, substituting "*right*" for "*left*," and "*left*" for "*right*," &c.

141. If the column is *closed in mass*, the wing nearest the intended line deploys "*By the rear of column*," as in Para. 91.



²⁸ Despite this being the same command as in Para. 136, it is broken into 4 parts, consistent with the actual manuals.

The Color Guard and General Guides

142. "The Color and *general guides* serve for the march of the battalion and to take general alignments."²⁹ The Color Bearer and *general guides* (ideally sergeants) are therefore chosen from among the best marching and most experienced soldiers.

143. In general, the Color Guard acts as part of the Color (*right center*) Company. It "counts-TWOS," doubles, and wheels with that company. It does not wheel on itself.

144. Ideally, the Color Guard, the most honored of posts, is composed of a Color Bearer (sergeant) and eight corporals - one on either side of the sergeant, and three each in the rear rank and in the line of file closers. Some manuals do not specify a file closer rank; Kautz suggests five corporals - no file closers. Living history battalions may (and Civil War battalions did) use a reduced guard.

145. "Each regiment of artillery and infantry has two silken colors, but only one is borne or displayed at the same time, and on actual [pre-war] service that is usually the regimental one."³⁰ During the Civil War, however, it seems that in general (but not always), Federals carried only the national colors into the field, reserving their regimental/state colors for ceremony [the author recommends this method].

146. If two colors are carried, Winfield Scott must be consulted: "The state [national] and regimental colors shall be borne by two sergeants, the former on the right."³¹ The two Color Bearers (sergeants or corporals), flank the Color Sergeant, who carries a musket; the 3-man front of the Guard is maintained.

147. The importance of the *right* and *left general guides* increases as the Battalion becomes larger since they help direct the flank companies when marching in line, and when changing the Battalion's general alignment. While not the same as markers (who may be staff or other file closers), a *general guide* may be used as one of the first markers in *successive formations*, if practicable. In a column of companies, the *general guides* do not necessarily guide the column (unless directed to), but march in their place in ranks, in the line of file closers (Figure 1). They may be called

²⁹ Le Gal, Eugene, *School of the Guides*, 1859, pg. 1.

³⁰ Scott, Henry L., *Military Dictionary*, 1861, pg. 164.

³¹ Scott, W., *Abstract of Infantry Tactics*, 1829, Para. 51. It is here implied that the civil flag is to the right of the unit flag.

out to the flank of the column to mark the position of the new battle line while the Battalion is moving near it.³²

148. The Color Bearer will normally carry the heel of the color lance (staff) on the right hip with his right hand at the height of his shoulder holding the lance steady. To salute, at six paces from the person to be saluted (*e.g.*, a general), the right hand is slipped upward on the lance to the height of the eye, and the lance lowered by straightening the arm, the lance's heel remaining on the hip. Six paces passed the saluted person, the lance will be returned to its normal position.

149. When the Battalion advances in line, the Color Rank (front rank of the Guard) moves out six paces at "*forward*," the rear rank of the Guard moving into the front rank, while those of the Guard in the line of file closers, if any, move into the rear rank. The Color Rank remains in front at "*HALT*," until the Battalion Commander orders:

Color and general guides - POSTS.

The *right* and *left general guides* act in a similar manner as the Color Rank, but at the right and left of the line, respectively.

150. When the Battalion is firing, the Color Rank steps into the rear rank, the Guard's rear rank stepping into the line of file closers. The Guard does not fire, but will reserve it for the defense of the Color. When the Battalion is to Charge (close with the enemy), the Color Rank returns to the front rank so that it is not precariously out in front; the general guides retire to the line of file closers.

Changing the General Alignment

151. When the Battalion halts in line of battle, and the Battalion Commander wishes to give it a general alignment (instead of dressing by the simple method of **Para. 104**), either parallel or *oblique* to the current line, he will not post the Color Bearer and *general guides*, but keep them in front, and have the Color Rank (except the Color Bearer) return to the front rank. But, if the Color Bearer and *general guides* are not already in front, the Commander orders:

Color and general guides - ON THE LINE.

and they will advance six paces in front of the Battalion.

³² See Hardee, Vol. II, Paras. 175-92.

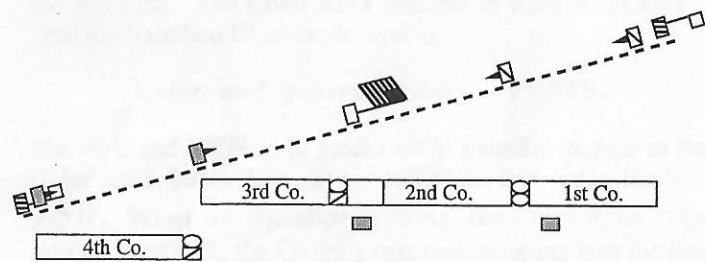

Figure 51: "Guides - ON THE LINE." Here, the Battalion is given a general alignment oblique to the current line. The company guides face the Color, and company commanders move to the inner flank (Color-side) of their companies (except the Color Company commander). The 4th company has retired a distance since part of it would have been in front of the new line. At the Battalion Commander's order of "On the Center - DRESS," the companies dress up to the near elbows of the guides, from center to flank.

152. With the Color Bearer and *general guides* in front, the Commander moves outside the *right* (or *left*) *general guide*, and has that *general guide* and the Color Bearer face him, the Colors now being held straight up. The Battalion Commander will then indicate the direction of the new line to the Color Bearer and *general guide* with his sword. When the Color and *general guide* are in the proper position, the other *general guide* dresses on them. So that the ranks may be easily aligned, the *general guides* should be well-seen, either with a guidon (camp color) on their muskets, or by holding their muskets vertical, butt upward, barrel to the right.

153. With this executed, the Commander then orders:

Guides - ON THE LINE.

(Figure 51) The outer company guides - right guides ("1st Serjts.") in the right wing and left guides ("2nd Serjts.") in the left wing - move onto the new line, all the guides facing the Color, a distance of a company front apart, each guide in front of where one of the three outside files of his company will lie. The company commanders of the right wing move to the left of their companies (except the Color Company commander, who moves into the rear rank), and those of the left wing move to the right of their companies.

154. When the outer company guides are assured of their positions *on the line*, the Battalion Commander orders:

On the center - DRESS.

at which the company commanders order their companies to advance, halt and dress onto the new line, up to the elbows of the guides, from the center (Color Company) to the flank companies. Each company *Supports Arms* when the company that follows it into line has dressed.

155. When the Battalion is dressed, the Commander orders:

Color and guides - POSTS.

The Color Bearer, company and *general guides*, and the company commanders return to their places in line of battle. The Color Bearer no longer holds the Color straight up, but on his right hip.

156. If the new line is such that one or more companies are presently in front of it, the Battalion Commander will have those companies move back so that the line is in front of the entire Battalion (Figure 51).

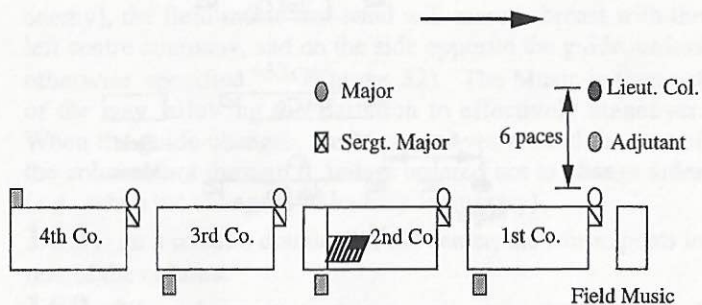

Figure 54: A Battalion marching by the right flank, with Music out in front.

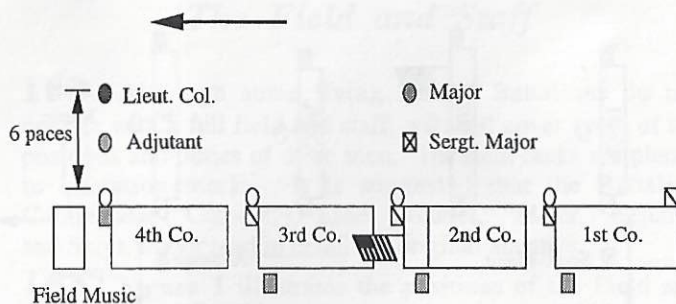

Figure 55: A Battalion marching by the left flank.

15 paces to the right of the Color Company commander, and endeavors to maintain the straightness of the line, especially the center companies. The "Major" is 6-8 paces on either flank of the Color Rank, and is principally responsible to ensure the Color is marching in the proper direction. The "Colonel" retains his position in rear of the line to oversee its movement. When the Battalion is to Charge (close with the enemy), the field officers return to their posts in rear of the line (Figure 1).

165. When marching *by the flank*, the field officers are on the side of the front rank - the side of the guide. When moving *by the right flank*, the "Lieut. Col." and "Major" are six paces to the left of the leading and Color files respectively; the Adjutant marches between the "Lieut. Col." and the leading file, the Sergt. Major between the "Major" and Color (Figure 54). The "Colonel" has no set position, but is usually 20 paces opposite the center of the Battalion on the side of the guide; in route marches, he is usually at the head of the Battalion.

166. When marching *by the left flank*, the field and staff take the same relative positions: the "Lieut. Col." and Adjutant to the right of the leading (leftmost) file; the "Major" and Sergt. Major to the right of the Color (Figure 55).

167. In a *column of companies or divisions*, whether a standard column or one doubled on the center, the "Lieut. Col." will march abreast the leading unit, six paces on the side of the guide. The "Major" will place himself similarly, in line with the last unit. The Adjutant will be between the "Lieut. Col." and the column, the Sergt. Major between the "Major" and the column (Figures 52, 53). In column of maneuver, the "Colonel" is generally 15-20 paces off the guiding flank.

168. In column, the "Lieut. Col." insures that the leading company guide marches in the proper direction, and the second guide follows in his trace. The "Major" will make sure that each of the other guides follow in the trace of the preceding guide.

169. In general, it is the "Lieut. Col." who places the markers to indicate the new line, and insures that the company guides dress correctly as they come onto line; the "Major" may assist with the guides as needed. Ideally, the company commander does not dress his company onto the new line until assured of the position of his guide by the "Lieut. Col."

170. In the movements, the Adjutant and Sergt. Major assist the "Lieut. Col." and "Major," respectively. It is at times easier to get to a place on foot than on horseback.

171. When the Battalion, in line, *faces by the rear rank*, the "Lieut. Col." and Adjutant will move around the Battalion's right flank, the "Major," and Sergt. Major around the left flank.

172. Except for the Adjutant and Sergt. Major, the positions of the Battalion Staff - Officers (Quartermaster, Surgeon, &c.) and NCOs (Quartermaster Sergt., &c.), are generally not prescribed for flank or column movements. In maneuver, the staff should march opposite the Battalion's center - so that when line is formed they are in their positions indicated in **Figure 1**. In route, the mounted staff may march in rear of the column, the foot staff behind the Music, or other place indicated by the Battalion Commander.³⁵

173. The Battalion Commander may wish to utilize one or more members of the staff as guides or markers; for example, to guide the Field Music (or head of column) in the proper direction, it being easier to instruct a guide on the route of march and have the Music follow him, than to attempt to instruct the Principal Musician who is busy leading the Music.

174. On *Parade*, the *Regulations* are silent on the positions of the staff; they remain in their positions in line of battle.³⁶ Strictly, the *Regulations* only require "All field and company officers and men"³⁷ to be present, not the staff.

175. At a *Review* (see the *Regulations*, Para. 349-374), when the Battalion is presented to the reviewing officers and the ranks are opened, the staff officers post three paces to the right of the company officers, one pace from each other by seniority from right to left; the NCO staff posts likewise, three paces on the right of the front rank of the Battalion. The Field Music posts as when on *Parade*.

³⁵ Upton's 1874 *Infantry Tactics* (Paras. 368-369) indicates that:
...In column, the staff marches abreast the center. ... In all battalion manœuvres, the non-commissioned staff, except the sergeant-major, conforms to the movements of the band [Music].

369. The staff and non-commissioned staff, except the adjutant and sergeant-major, may be excused from battalion manœuvres [drill], except when preparing for forms of ceremony.

³⁶ Such is also implied in Upton's 1866 *Infantry Tactics*, Appendix No. 1, and later manuals.

³⁷ *U.S. Army Regulations*, Para. 347.

Battalion Firing

176. When the Battalion fires, the Color Guard steps back one rank, the Color Rank into the rear rank of the Battalion. The Guard will not fire, but save its fire to defend the Color.

177. When firing, each company commander posts at the center of his company, 4 paces in rear of the file closers; each "1st Sergt." posts behind his interval, in the line of file closers to observe his company (Figure 56).

178. To fire by Battalion:

1. *Fire by battalion.* 2. **READY.** 3. **AIM.**
4. **FIRE.** 5. **LOAD.**

179. To fire by wing:

1. *Fire by wing.* 2. *Right (left) wing.* 3. **READY.**
4. **AIM.** 5. **FIRE.** 6. **LOAD.**

and each wing will alternate firing.

180. To fire by company (company volleys):

1. *Fire by company.* 2. *Commence firing.*

At the second command, the *odd-numbered* (right) companies of each division will fire *by company*, the 3rd company firing *slightly after* the 1st company, and so on if there are more odd-numbered companies; this is so that the companies will not all fire at the same time. When the *odd-numbered* company of each division has loaded and several men are at *Ready*, the *even-numbered* (left) company fires. Each division coordinates its fire thusly, the two companies taking turns, like pairs when skirmishing.

181. To fire by file:

1. *Fire by file.* 2. *Battalion.* 3. **READY.**
4. *Commence firing.*

Each company will fire *by file* simultaneously, and the men will then continue to fire *at will*.

182. At "*Cease-FIRING*," all firing will cease. The men will load and come to *Shoulder Arms*.

183. Firing *by company* or *by file* should always be direct. Firing *by battalion*, *by wing* or *by rank* may be oblique or direct.

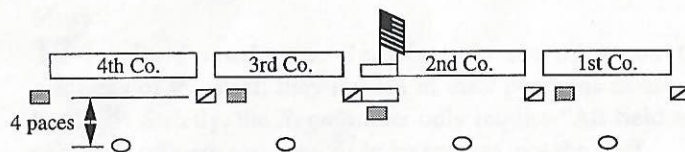

Figure 56: Battalion prepared to fire. The company commanders post 4 paces in rear of the line of file closers opposite the centers of their respective companies; the "1st Sergeants" post in the line of file closers, opposite their respective intervals. The Color Rank moves into the rear rank of the Battalion, and the rear rank of the Guard moves into the line of file closers.

ASSEMBLY OF THE BATTALION

AUTHOR'S NOTE: This subject being of basic importance and essentially "one maneuver," we step away from the numbered paragraph system and present the Assembly as an "article" unto itself.

184. Despite its fundamental importance, the assembly of the Battalion is not explicitly covered in the standard *Tactics* manuals; they simply state that:

1. EVERY colonel will labor to habituate his battalion to form line of battle, by night as well as by day, with the greatest possible promptitude.
2. The color-company will generally be designated as the directing company. That, as soon as formed, will be placed on the direction the colonel may have determined for the line of battle. The other companies will form on it, to the right and left, on the principles of successive formations which will be herein prescribed.³⁸

As noted in **Para. 79**, *successive formations* are movements in which the Battalion line forms one company at a time. It is up to the reader to extract the method for forming the Battalion from the principles "herein prescribed."

SIGNALS (by the Bugle or the Drum)³⁹

In the instructions for musicians given in the standard manuals, we find that:

When the whole of the troops, in the same camp or garrison, are to depart, *the general, the assembly, and to the color*, will be sounded, at the proper intervals, in the order here mentioned. At the first, the troops will prepare for the movement; at the second, they will form by company, at the third unite by battalion.⁴⁰

The General is actually the signal to break camp (*i.e.*, to take down tents an hour before departing). More often, the Battalion is formed without breaking camp. In this case, the *Drummers' Call* (beaten on the drum), or *Assembly of the Buglers* or *Attention* (sounded on the bugle), are reasonable substitutes. Bruce and Emmett, in their instructions for Guard Mount, specify that the

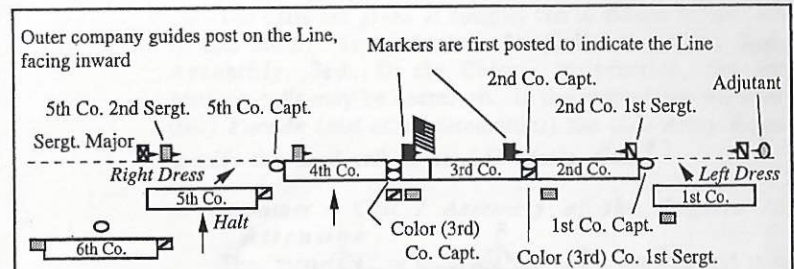

Figure 57a: Forming a 6-company Battalion. At *The Assembly*, the Adjutant posts two markers on which the Color Company (here the 3rd) forms. At *To the Color*, the other companies march to the Battalion Parade. Each company halts 3 paces before it comes into line, its outer guide posting on the line of markers (facing them), its Captain moving to the flank of the preceding company - towards the center of the Battalion (see 1st, 2nd & 5th Cos.). As each guide comes onto line, the Adjutant (or Sergt. Major) assures that the guide is on the line of markers, and then his Captain dresses the company; the Adjutant (Sergt. Major) moves towards the flank to direct the next guide. Each company comes to *Support Arms* when the next company into line has dressed and fronted.

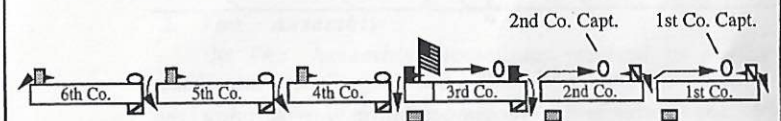

Figure 57b: Posting the Guides. After the line is formed, the guides remain in front until the Adjutant is satisfied with the alignment; he then orders, "**Guides - POSTS.**" (when maneuvering, it is the Colonel who orders "**Guides - POSTS.**"). At "**Guides - POSTS,**" the Captains and the guides return to their regular posts, the guides through the nearest company interval, formed by each Captain and 1st Sergt. moving in front of, and in rear of, their rightmost files.

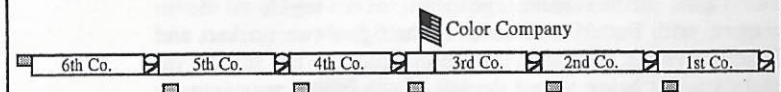

Figure 57c: A Battalion in line of battle. Note that the leftmost 2nd Sergt. closes the Battalion, and there is no space between companies. If there is a file closer rank to the Color Guard, the 2nd Sergt. of the Color Company is to their left, behind the 1st Sergt. of the next company to the left.

³⁸ Scott, Winfield., *Infantry Tactics*, Vol. II, Paras. 1-2. Hardee, Vol. II, Paras 1-2. Casey, Vol. II, Paras. 1-2.
³⁹ Hardee, Vol. I, pg. 221: bugle calls. Casey, Vol. I, pg. 234, Scott, Vol. I, end pages: bugle calls and drum beats.
⁴⁰ Scott, Vol. I, pg. 170. Hardee, Vol. I, pg. 219. Casey, Vol. I, pg. 230.

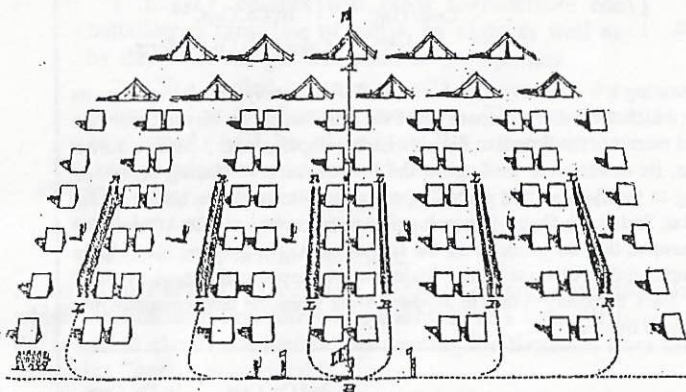

Figure 58: Butterfield's recommendation for forming the companies in their streets before marching to the Parade - right wing companies facing to the right flank, left wing companies to the left flank. This method allows the officers and sergeants to address their companies without "addressing" the next company. In general, the companies should face in the direction which is most practical for marching to their place in line, but facing each other should be avoided if possible.

The figure causes some confusion as it seems to be in disagreement with Butterfield's text. In the figure two markers and the Color Bearer are posted on the Color Line, the left marker (to the reader's right) being where the left of the left-center company will lie. The written instructions properly call for the left marker to be placed where the left of the Color Company is to rest (*i.e.*, where the Colors are to post).

Source: Butterfield, D., *Camp and Outpost Duty*, 1862, pg. 71.

"first call" is the musicians' call,⁴¹ as does Kautz (see below). At living history events, either in camp or on the march, this author often has *Attention* sounded, the musicians being so few and the men being well accustomed to the sound of *Attention*.

The calls are given at roughly ten to fifteen minute intervals, in this order: **1st. Musician's Call/Attention. 2nd. The Assembly. 3rd. To the Color.** In practice, the intervals between calls may be decreased. In the instructions for conducting daily *Parade* (and other ceremonies), the *U.S. Army Regulations* specify the third call to be *Adjutant's Call*.⁴²

1. *Drummer's Call / Assembly of the Buglers / Attention*

The "first call" is to assemble the musicians, and is used as the signal to prepare to form ranks - the men should listen for the next call, and prepare to fall in; they will recognize that since the musicians are forming, they also will likely be forming. Indeed, Kautz notes that:

428. The company is formed in the interval between the *musicians' call* and the last note of *assembly*, when every man should be in ranks.⁴³

It should be noted that the *musicians' call* is also beaten before Guard Mount, &c., so the officers and "1st Serjts." should be aware of the schedule/Battalion Commander's intent.

2. *The Assembly*

At *The Assembly* (sometimes referred to as the "first call"), the "1st. Serjts." and NCOs form their companies on their respective parade grounds (*i.e.*, the company streets) under the supervision of their officers, the Field Officers having general supervision. The roll may be called. The Battalion Commander moves to the Battalion Parade Ground or other place where the Battalion is to form, while the Adjutant forms the Color Guard, posting it on the left of the Color (*right center*) Company.

The Adjutant then posts two *markers*,⁴⁴ facing to the right, one each in front of where the right and left of the Color Company are to lie (Figure 57a). The right elbows of the markers indicate the line upon which the Battalion is to dress. The Sergt. Major assists the Adjutant in his various duties. The Adjutant will then align himself with the markers, facing them, about a company distance from them, on the right wing, waiting to post the next company's guide on the line of markers; the Sergt. Major will do the same on the left wing. The companies prepare to move to the line.

⁴¹ Bruce and Emmett, pg. 38.

⁴² *United States Army Regulations*, Para. 339.

⁴³ Kautz, August V., *Customs of Service for NCOs and Soldiers*, Para. 428.

⁴⁴ See Notes "On Markers," pg. 69.

3. *To the Color* (or, *Adjutant's Call*)

At *To the Color*, the Color Company marches to the markers and dresses on them. However, in the spirit of Para. 2, "School of the Battalion," and to ensure that the line is properly established, this author often has the Color Company formed on the line before *To the Color* is sounded. The Color Company should dress to the left, its "Captain" (company commander) moving to the left of the company to do so, the left file aligning on the left marker.

At *To the Color*, the remaining companies also march to the Parade Ground - the companies on the immediate left and right of the Color Company arriving first, the flank companies last. Each company waits until the preceding company is dressed before it moves onto line (**Figure 57a**). After sounding *To the Color*, and especially on Parade, the music generally plays martial airs as the companies march to the line.

As each company arrives, it halts 3 paces behind the line. Its outer guide automatically posts on the line of markers, facing inward (to the Color), in front of where one of the 3 outermost files of his company will lie. This "outer guide" is the right guide ("1st Sergt.") if the company is in the *right wing*, the left guide ("2nd Sergt.") if in the *left wing*. The Adjutant, posted on the line of markers, assures the positions of the *right wing* guides as each comes on to line, moving from the inner company to the flank; the Sergt. Major does likewise with the *left wing* companies.

The "Captain," in the meantime, moves to the near flank of the company which proceeded his into line, at the side of that company's front rank man. A right wing "Captain" posts to the right of the senior corporal of the company to the left; a left wing "Captain" posts at his normal position in line at the left of the leftmost file of the company to the right. The "Captain," assured that his guide is on the line by the Adjutant (or Sergt. Major) then dresses his company towards the center; *i.e.*, "**Left-DRESS**" if in the *right wing*, "**Right-DRESS**" if in the *left wing*. A *right wing* "Captain" does not return to the right of his company until the Battalion is ordered, "**Guides-POSTS,**" as noted below. Note that each company dresses towards its "Captain" and up to the near elbow of its outer guide.

Each "Captain" orders his company to Support Arms when the company that follows his into line has dressed and fronted. By coming to *Support Arms*, the "Captain" indicates that he believes his company is properly dressed. This rule is *general* for all *successive formations*, unless the Battalion is ordered to immediately fire.

When the alignment is satisfactory, the Adjutant orders:

Guides - POSTS.

The guides, markers and "Captains" return to their places in line of battle as shown in **Figure 57b**. Each guide (and marker) passes through the nearest company interval, made by the "Captain" and

"1st Sergt." moving, respectively, in front of and in rear of, their company's rightmost file.

The Battalion is now formed (**Figure 57c**), and is ready for **Parade (Para. 11)**, to move onto the drill or battle field, or to take up the march.

185. Forming the Battalion may also be found in Winfield Scott's *Abstract of Infantry Tactics*.

Notes from a Higher Authority

Scott, Winfield, *Abstract of Infantry Tactics*, 1829.

[with notes by D.J. Dal Bello]

804. Every Colonel will exert himself to give to his battalion the habit of forming with the greatest rapidity.

805. At the first call,^a the colonel will repair to the place of assembly previously designated for the battalion, and each captain to that of his company. The other company officers, and the non-commissioned officers, will hasten to turn out, and assemble their men; and the lieutenant-colonel and major will superintend and quicken the formation of the companies.

806. Each captain will post his file-closers, and instantly form his company with a front not exceeding the number of files previously indicated by the adjutant.^b The color company will be formed with a front three files less than that number [for the 3 files of the Color Guard].

807. The adjutant will, at the same time, form the color-guard on the left of the [Color] company, and distribute the surplus files of the stronger companies among the weaker.^c He will be assisted in these duties by the sergeant-major.

808. The colonel will cause a roll of the drum to be given, to announce that the companies ought to be ready to unite, and afterwards a tap of the drum, as a signal for each company to march and form on the line or company previously designated [or, play *To the Color*].

809. The battalion will form line according to the principles of successive formations, which will be herein prescribed.

Notes

^aHere, Scott means *The Assembly*. A call is played beforehand to assemble the musicians.

^bFrom the morning reports, the Adjutant divides the effective strength (corporals and privates) by the number of companies. For maneuvering only, the companies are *equalized* to make the movements more precise; it is difficult to maneuver if company size varies significantly

^c"Equalizing" may be a difficult matter in living history units, unless there is good cooperation among the companies.

Marching from the Company Parades

186. In his 1862 *Camp and Outpost Duty for Infantry*,⁴⁵ Dan Butterfield also explains how the line is formed for Parade. For completeness, the author includes some relevant instructions that Butterfield gives on how the companies get from their individual parades (company streets), to the Battalion parade ground (**Figure 58**).

Article XVII DRESS PARADE

1. The proper formation of a dress parade adds much to its effectiveness, simplicity and precision.

2. To form the line properly, captains of companies will form their companies in their company streets in the manner indicated in the diagram [**Figure 58**] viz.: The companies of the right wing faced toward the right flank of the camp, the left or second sergeants nearest the color line, the first sergeants nearest the company officers' tents, as indicated by the letter R for first sergeants, L for second sergeants.

3. The companies in the left wing faced in the reverse direction.

4. "The Assembly" should sound thirty minutes before the formation of dress parade, when the first sergeant should cause the company to fall in, in the position prescribed in the diagram, call the roll, and turn it over to the captain. The captain then sees that the equipments are all clean and neat, clothes buttoned up, boots blacked, and every thing in proper order, the company at parade rest, and then give a short exercise in the manual, mark time, alignments, etc.

5. At the hour for formation the drums beat the first part of "the Troop;" instantly each captain gives the command "Attention, company." "Shoulder arms." "Right (or left) face." (The companies of the right wing face to the left, those of the left wing face to the right.)

6. At the same instant the adjutant, with the markers, with their colors, being formed in front of the colonel's quarters, will march forward on the line AB [between the tents of the center companies]. The adjutant will halt on the color line, station the guides and markers for the formation of the color company, so that the color sergeant will be exactly at the center of the battalion [camp], one marker where the right of the color company will rest, the other where the left of the color company will rest.

7. The instant the adjutant arrives on the color line, the band will commence to play. All the captains of

companies will give the command "Forward!" the moment the drums cease the "the Troop." The instant the band commences to play, the command "March!" will be given by all the captains.

8. They will then move their companies on to the line, the color company moving a little in advance in the direction indicated by the dotted line and index in the diagram.

9. The right guides of right companies, and left guides of left companies, throw themselves on the line the moment their companies are halted.

10. They will remain in front of their companies until the adjutant gives the command "Guides post!"

11. The captain of the color company will align his company on its left, and then give way for the captain on his left to align his company, taking his post on the right at the command "Guides post."

12. The captains of the right wing align their companies by the left, and change to their proper position at the command "Guides post." Each captain will immediately, as soon as his company is aligned, give the command "Front!" ... "Support arms!" As soon as the line is formed, each captain will follow the Regulations, as prescribed in paragraph 339, New Army Regulations, and following.

13. The companies, while marching to the line of formation, should never halt (but mark time) until halted in their proper position, one [three] pace[s] in rear of the line, for alignment. A good officer will oftentimes execute effective and handsome movements while approaching his position in line. Seeing that he will have to be delayed a moment, he sometimes marches in rear of and covering the company next to him on which he is to form, then comes handsomely by the right about back again to halt just at the right moment and in the right place. Again, he will sometimes march several paces in rear of the line, and come forward to the line by flanking his company, and come up to the line by company front.

The reader should note the advantage of forming the companies in their streets as described by Butterfield. First, no two companies are facing each other, which minimizes interference between the roll calls and other company orders. Secondly, the companies are most easily marched to the parade ground. However, at times it may be better for all the companies to face the same way, such as when the camp's front is smaller than that of the battalion line (as when camping by divisions).

⁴⁵ Butterfield, Daniel, *Camp and Outpost Duty for Infantry*, 1862, pages 69-72.

TABLE II: Posts of Company Commanders, Company Guides, the Color Rank and General Guides in Battalion Movements.

FORMATION	Co. Commander (Captain)	Co. Right Guide (1st Sergeant)	Co. Left Guide (2nd Sergeant)	Color Rank	General Guides (Right; Left)
Line of Battle	On right flank of company in front rank	On right flank of company in rear rank (behind Captain)	In line of file closers, one file from left flank of company [1]	In front rank of Color Co.	In line of file closers, behind right and left flanks of battalion
Marching Forward in Line	On outer flank of company in front rank	On right flank of company in rear rank [2]	In line of file closers [3]	6 paces in front of front rank; rear rank of Guard in front rank	6 paces in front of right and left flanks of battalion
Firing	Center of company, 4 paces behind file closers	In line of file closers, opposite place in line of battle	In line of file closers	In rear rank; rear rank of Guard steps into line of file closers	In line of file closers
By the Right Flank	To the left of 1st Sergt.	In front of <i>Ones</i> of front rank	In line of file closers [4]	In ranks (<i>doubled</i>)	In line of file closers
By the Left Flank	To the right of 1st Sergt. of company to the left [5]	In front of <i>Twos</i> of front rank of company to the right in line [6]	In line of file closers [7]	In ranks (<i>doubled</i>)	In line of file closers
Column of Companies	2 paces in front of center of company	On right flank of company	On left flank of company [8]	In front rank of Color Co.	In line of file closers [9]
Column of Divisions Right Co.; Left Co.	Senior Capt: 2 paces in front of center of div.; Junior: in front rank, between companies	Right Co.: on right flank of division, in front rank; Left Co.: in rear rank, between companies	Right Co.: in line of file closers at left of co.; Left Co.: on left flank of division, in front rank	In front rank of Color Co.	In line of file closers [9]

[1] In line, the left guide of the leftmost company is in the front rank at the left of the battalion (except when the battalion is firing); he "closes" the battalion.

[2] The 1st Sergt. to the left of Color Guard is in the front rank.

[3] The leftmost 2nd Sergt. is behind the leftmost Captain.

[4] The leftmost 2nd Sergt. posts in the line of Captains.

[5] The leftmost Captain is to the right of his own 2nd Sergt.

[6] The rightmost 1st Sergt. posts in the line of Captains.

[7] The leftmost 2nd Sergt. posts in front of *Twos* of his own front rank.

[8] A general rule in battalion movements is that whenever a company's left flank is uncovered, it's left guide moves up to the left flank of the company; he returns to the line of file closers when the company to the left is to reconnect.

[9] Usually, Genl. Guides remain in the line of file closers; if necessary, they may be called out to guide the company guides, especially in columns of more than one battalion.

NOTES

Notes from H.L. Scott's Military Dictionary

MANŒUVRE.

...In marches near the enemy the columns should march at half distance, when roads permit, in order that they may be less elongated, and all the troops be ready to act promptly. If surprised in this order by the necessity of forming immediately forward into line of battle, or, if without being under this pressing necessity, there is between us and the enemy ground admitting an easy march in line of battle, the column ought to execute forward into line, according to the principles of the tactics. This movement is more prompt and greatly better than closing column in mass, in order to deploy afterwards. In the first case troops only pass over one side of the triangle, whilst by massing the column to deploy afterwards, they must pass over two sides by a complicated manœuvre, which is dangerous from the beginning.⁴⁶

...Flank marches, in presence of the enemy, ought always to be made in open column. In this order we are always ready to fight by a simple wheel of each subdivision of the column.

...Troops cannot be too much exercised in marching in line of battle.

...Changes of front very near the enemy are rarely perpendicular. The new front nearly always forms with the line of battle an acute angle. In this case, it is necessary to guard against breaking the battalions into column. It is better to use the changes of direction for the line of battle prescribed by the tactics.

...Changes in front forward are possible under fire, but changes of front to the rear are not so. ... To make the movement, it is necessary first to stop the enemy, and the means of doing that vary with circumstances, and the resources within our command.

⁴⁶ Note that both Hardee and Casey prescribe that a column at half distance should *close in mass* to deploy forward. However, deploying forward as when at full distance may be done by having the 1st company move forward a suitable distance, the other companies wheeling more than they normally do when at full distance.

On Repeating Commands

In the main text, the author warned against the Battalion Commander's commands being repeated. Obviously, the wind or sound of firing may necessitate repetition by Field Officers and even company commanders (and NCOs on the skirmish line), but this should be kept at a minimum - perhaps to just the Field Officers, Adjutant and Sergt. Major, if necessary. If the Battalion Commander can be heard by all, there is no need to repeat him and risk "stepping" on his next command.

Members of the companies should remain silent so that the Battalion Commander can continue to be heard. At most, company commanders warn their men in undertones what movement they are to execute.

Careful readers will have noted two exceptions: when the Battalion is in a *column of companies* (division, &c.), the commands of *execution* - "HALT" and "MARCH" - are to be "promptly," or "briskly," repeated by the company commanders (chiefs of subdivisions). The reason for this is explained in Hardee's "School of the Company"⁴⁷ (emphasis by this author), where the movement of a *column of platoons* is described:

198. At the command *march*, promptly repeated by the chiefs of platoon, they, as well as the guides, will lead off, by a decided step, their respective platoons, in order that the whole may move smartly, and at the same moment. ...

210. In column, chiefs of subdivision will always repeat, with the greatest promptitude, the command *march* and *halt*, no chief waiting for the other, but each repeating the command the moment he catches it from the instructor. They will repeat no other command given by him; but will explain if necessary, to their subdivision, in an undertone of voice, what they will have to execute, as indicated by the [Battalion Commander's] commands of caution. ...

233. If the command *halt*, be not repeated with the greatest vivacity, and executed at the same instant, distances will be lost.

⁴⁷ See also Casey, Vol. I, "School of the Company," Paras. 203, 215, 238.

Hardee's instructions make sense - each subdivision must step off or halt at the same time. A moment's delay in halting will close the distance between subdivisions a step or two, which will cause them to overlap if the column wheels into line. Conversely, a delay in stepping off will open the column, which unless rectified while marching, will cause gaps when the column wheels back into line.

In large columns, visual signals from the Battalion Commander may be needed (although they are not prescribed in the manuals) in order that the commanders of subdivisions all order "MARCH" or "HALT" at the "same" time, sound traveling much slower than light. Note that this does not imply sword movements made by the company commanders to indicate changes of direction/halting, &c.; such "Drum Major"-like movements are not found in period manuals.

On Markers

In their respective *Infantry Tactics*, Hardee and Casey make great use of *markers*. *Markers* are used to indicate the point where companies are to start their wheels when a column of companies is to change direction; they are also used to indicate the orientation and position of a new line of battle. For example, in changes of direction, the Battalion Commander

will go to the point at which the change ought to be commenced, and establish a marker there, presenting the breast to the flank of the column.⁴⁸

However, markers are often referred to almost as inanimate objects. It is implied that they are soldiers, but it is nowhere stated who they are. What are markers? are they guidons planted on the ground? Staff officers? Who are they? &c.

Egbert L. Viele's 1861 *Hand-book for Active Service*, states that:

Three markers are required to every battalion; they are posted behind the first company in the rank of file-closers, when the battalion is in line, and behind

⁴⁸ Hardee, Vol. II, Para. 231.

the leading company or division whenever it is in column.⁴⁹

The 1858 *General Regulations for the Military Forces of New York*, one of the better militia systems before the War, specify that:

550. The Lieutenant Colonel of each regiment will select two or more persons from the sappers and miners, or from the corporals in the line, to act as markers in the exercises of the regiment. They will be carefully instructed by the Lieutenant Colonel in the duties required of them in the practice of the school of the battalion ... and they will be under the special direction of the Lieutenant-Colonel during the manœuvres.⁵⁰

Last, but not least, Winfield Scott in his 1835 *Infantry Tactics* prescribes in the instructions for musicians that:

Pioneers and drummers may be designated as markers and used accordingly, in the manœuvres and evolutions.⁵¹

Thus, there is precedence that markers may be drawn from the corporals and pioneers, and even from the drummers. In practice, markers could of course be any soldier available or specially detailed.

Note that markers are in addition to *general guides*. Again, Viele suggests that there are ideally 3 markers per battalion.

When markers are placed to indicate a new line of battle, they post just under a company front apart, facing to the right if posted in front of where a right wing company is to lie; they face to the left if in front of a left wing company's position. After the "base" company dresses on the markers, the other companies approach the line, from closest company to furthest, forming the Battalion line by the principles of *successive formations*, their outer guides dressing on the line of markers.

⁴⁹ Viele, Egbert L., *Hand-book for Active Service*, 1861, pg. 40. It seems that it was not until Upton's 1874 *Infantry Tactics* that markers were explicitly identified in an "official" manual in the section on the formation of a battalion (*i.e.*, along with posts of field officers, general guides, &c.); Upton specified 4 markers per battalion.

⁵⁰ *General Regulations for the Military Forces of the State of New York*, 1859, Paras. 549-550.

⁵¹ Scott, Winfield, *Infantry Tactics*, Vol. I, 1835, pg. 173. Knowlton, Miner, *Instructions and Regulations for the Militia and Volunteers of the United States*, 1861, pg. 56.

Concerning Wheels

Wheels with Movable Pivots

When a *column of companies* is to change direction (**Para. 61**), each company wheels when it reaches the point (the *marker*) where the change of direction is to occur. The pivot point of these wheels must be cleared so that the following companies may wheel at the same spot without crowding. These wheels are often called "*moving wheels*." The men look towards their *guide* on the outer flank of the wheel, and maintain elbow contact with the man to the outside - "Look out, touch out." The pivot man moves 9 inches per step. The outside guide must take care not to march in too large of a circular arc, else distances between companies will be lost and the files spread apart. Each guide should trace the same path so that each company, no matter its size, wheels in the same amount of time.

The term "moving wheel" should more properly be a "wheel with a movable pivot," or a "moving-pivot wheel." Just because a company is moving before and after it wheels, does not necessarily mean that its pivot moves, as explained below.

Wheels with Fixed Pivots

A Battalion often changes its formation from line into column, or from column into line, by company wheels. In these cases, even when the line or column is initially moving and either continues to move or halts after changing its formation, the wheels are on fixed pivots - "Look out, touch in." For instance, when wheeling right into a column of companies from a line of battle, the rightmost front rank man simply faces right (**Para. 24**). The reason behind the fixed wheel is that the companies must maintain a common reference - all the pivot points are on a single line.

These wheels must be fixed as all the companies are wheeling at once. It is vital to first, maintain proper distances between companies (as when wheeling from line into column - **Figure 13**), and second, to insure that the guides remain in line (as when deploying a column to the left into line - **Figure 30**). These two conditions can only be maintained if the "moving" wheels are fixed.

If the wheels are not fixed when deploying a moving column to the left into a moving line (**Figure 30**), then the companies will be "staggered" as they enter the new line.

These observations on company wheels are actually "hidden" in the "School of the Soldier:"

378. Wheeling on a fixed pivot takes place in passing a corps from the order in battle to the order in column, or from the latter to the former.

379. Wheels in marching [moving pivots] take place in changes of direction in column, as often as this movement is executed to the side opposite to the guide.⁵²

On Casualties

The manuals of Hardee and Casey at times seem to be written for someone who already had some idea of military practices. Many of the valuable "Remarks" and explanations found in Winfield Scott's earlier manuals are not found in "Hardee's or "Casey's." One such example is the issue of *casualties*. What happens when a casualty is taken?

It has been ingrained into reenactors' minds to "**Right-DRESS**" (or *Left*, or *Center*). Thus, it has been common practice in reenacting to "cover down" when casualties are taken. However, something seems inherently wrong with this method. In battle, dressing down would be a constant process, and results in the line continuously shortening, among other difficulties.

Fortunately, in his 1835 *Infantry Tactics*, Scott instructs:

16. ... Files having been formed, as often as a front or centre rank [if in 3 ranks] man falls or steps out of his rank, he will be immediately replaced, for the time, by his coverer in the next rank.⁵³

Thus, if a casualty is taken, the rear rank steps up. This provides several benefits:

- (a) The battalion's frontage is maintained.
this is vital in maintaining proper distances between battalions (ideally 22 paces), as well as continuing to actually cover and show the enemy a "full front."
- (b) No one crosses in front of the rear rank as it fires.
another safety issue "built-in" to the *Tactics*.

⁵² Hardee, Vol. I, "School of the Soldier," Paras. 378-9.

⁵³ Scott, Vol. I, 1835, "School of the Soldier," Para. 16.

- (c) The men's file numbers (1-2) are maintained, at least temporarily.

this is a "fortunate result" as the formal *doubling* of the Civil War era was not prescribed for United States service until 1855 with the latest translation of the French system.

Scott does not instruct us what to do if a whole file (or more) is taken out of action. One must assume that the front rank continues to be filled by those in the rear rank in order to maintain the Battalion's frontage. If a large section is taken out of action, then the situation must be rectified by the field or line officers.

Route Marches by the Flank

August V. Kautz's *Customs of Service for Officers* (1866) instructs us that the position of the company commander when the Battalion is ordered to *route step* is not at the "head" of his company:

666. The march of Infantry, except when expecting an engagement, should be by the flank; it should move out in order, and when fairly on the road, the leading company is directed to take the *route step*, and should be succeeded by every other company in the same way. When each Captain gives the command to take the *route step*, he passes from the front to the rear file, in order that he may better observe the men who fall out of ranks. The Captain should be provided with tickets, that authorize the men who are unable to march to fall out, in order that they may show this authority to the Provost Guard, or Rear Guard, that should be directed to bring forward all stragglers. All men absent from their companies, without written authority, should be arrested.⁵⁴

Besides the disciplinary reasons, it is good practice, especially in long marches, for the company officers to observe the general welfare of their men.

The company commander marching in rear of his company during route marches is also prescribed in Viele's 1861 *Hand-book*, which echoes D.H. Mahan's *Outpost Duty*, originally printed in 1847. And, in theory,

⁵⁴ Kautz, *Customs of Service for Officers*, 1866, Para. 666.

The captains are always provided with tickets bearing their own signature; on each is written, "The bearer has my permission to fall out of ranks, being unable to proceed with the regiment." Any soldier found on the line of march by the rearguard, without a ticket, is liable to be punished for disobedience of orders.⁵⁵

How often the practice of issuing tickets, &c., was actually followed during the War remains a question.

Mahan⁵⁶ actually cites British Lieut. Col. Leach's work, *On the Duties of Troops composing the Advanced Corps of an Army*. From this source, Mahan also recommends:

If a soldier wanted to fall out of the ranks for a few minutes only, he was required to ask leave of the captain to do so, and moreover, to take off his knapsack and to give it, together with his musket, in charge of the men of his section.

This allowed the man to more readily catch up with his company, as well as give him incentive to return quickly, else face the "displeasure" of his comrades.

Finally, Mahan (Leach) notes that just before the column is to halt, and as it begins to march again, it is to march with order and in step:

Preparatory to ... halts, the word of command, "Attention!" was given at the head of the leading regiment, and passed rapidly from company to company. Upon this, the captains moved quickly from the rear to the front; the arms of the soldiers regularly shouldered or slung, perfect silence was observed... and in an instant there was a magical change from apparent irregularity to most perfect discipline and order.

On resuming the march after these halts, the troops observed the same extreme regularity during the first hundred or two yards ...

End

⁵⁵ Viele, pp. 50-51.

⁵⁶ Mahan, D.H., *Advanced-Guard, Outpost and Detachment Service of Troops*, 1847, Para. 342.

Contents and Cross References

The following tables contain a listing of the paragraphs in this work (in boldface). The paragraphs have been cross-referenced to the relevant paragraphs of the original works. If the reference is to a page number, the number is prefaced with a lower case "p").

Formation of a Battalion

The sources for *Formation of a Battalion* are Vol. I of both Hardee and Casey's *Infantry Tactics* ("Formation of the Battalion"), Le Gal's *School of the Guides* (the page number prefaced with a "LG"), and Viele's *Hand-book for Active Service* ("V").

Formation of a Battalion	PIE	Hardee I	Casey I
Formation	1	1	6 *
Ordering of Companies	2	2	7
Numbering of Companies	3	3	8
Divisions	4	4	11
Position of Color Guard	5	7,36,38	14,43,45
Right and Left Wings	6	7	14
General Guides	7	40,41 V p40	47,48 LG p1
Equalizing Companies	8	11	18
Presentation of this work	9	25	32

* As amended by Sec. of War, E. Stanton in his "Forward" to Casey's.

Parade and Inspection

The main source for *Parade* and *Inspection* is the *United States Army Regulations*; 1861. Upton's *Infantry Tactics* (1874) is used where the *Regulations* failed to go into detail, or needed clarification. Paragraphs which are cross-referenced to Hardee (Vol. II), Casey (Vol. II), Kautz's *Customs of Service for NCOs*, or Bruce and Emmett's *The Drummers' and Fifers' Guide*, are prefaced with H, C, K or BE, respectively.

	PIE	Regs.	Upton
DRESS PARADE	10-22	337-48	810
Music, <i>beat off</i>	13		BE p38
To open ranks	14	340-1	H22, C27
1st Serjts.' Reports	18	344	K438
INSPECTION	23-33	303-20	816
Right wheel into column	24	307	H68, C77

Evolutions

The main sources for *Evolutions* are Vol. II of both Hardee's and Casey's *Infantry Tactics*.

Paragraphs which are cross-referenced to other sources are prefaced by a reference letter, indicated here:

Scott, 1835, Vol. I, "Formation of the Battln.:"	s
Hardee, Vol. I, "Formation of the Battalion:"	h
Casey, Vol. I, "Formation of the Battalion:"	c
Hardee, Vol. I, "School of the Company:"	hc
Casey, Vol. I, "School of the Company:"	cc
Le Gal's <i>School of the Guides</i> :	LG
H.L. Scott's <i>Military Dictionary</i> :	md
Kautz's <i>Customs of Service for NCOs</i> :	K
W. Scott's <i>Abstract of Infantry Tactics</i> :	SA
<i>United States Army Regulations</i> , 1861	R

e.g., "h p217" refers to Hardee, Vol. I, page 217; "h30" refers to Para. 30 of the "Formation of the Battalion."

General comments are labeled with a dash, "- ."

EVOLUTIONS	PIE	Hardee II	Casey II
Battalion drill	34	-	-
Companies and Divisions	35	-	-
Right and Left	36	-	-
Left guides	37	-	s33
Marching by the Flank			
To march by the right flank	38	722	805
To return to line	39	732	817
To march by the left flank	40	725	809
By companies into line	41	734	819
From Line into Column			
To wheel by company to the right or left	42	68	77
Break to the rear by the right of cos.	43	87	108
To the rear into column	44	90	112
To the rear by the right, while marching	45	96	121
To break most promptly	46	104	134
Ploy into closed column on 1st company	47	117	157
Ploy into closed column on 4th company	48	141	190
Ploy into column on inner companies	49	143	193
Ploy into column, marching	50	149	200
Ploy into open column	51	159	213
Closing and Opening a Column			
Close column to half distance	52	252	294
Close column while marching	53	263	309
Close column on last company	54	267	316
Close in mass	55	279	333
Take distances by the head of column	56	323	386
Take distances by the rear of column	57	333	397
Simplest methods	58	-	-

EVOLUTIONS

PIE Hardee Casey
II II II

EVOLUTIONS	PIE	Hardee II	Casey II
Maneuvering a Column			
<i>At Full Distance</i>			
March of column at full distance	59	164	219
To march to the rear	60	170	225
To change direction at full distance	61	231	273
To halt a column	62	239	286
To dress entire column on lead guides	63	244	291
To adjust some guides	64	243	290
To wheel to the right to march to the left	65	86	106
<i>Column at Half Distance</i>			
In presence of the enemy	66	N/A	232
March of a column at half distance	67	281	335
<i>Column Closed, In Mass</i>			
Change direction, marching	68	288	345
Change direction, from a halt	69	306	365
<i>Column of Companies to One of Divisions</i>			
To form column of divisions, from a halt	70	380	453
Form column of divisions, moving	71	376	449
Form column of divisions, closed in mass	72	364	437
Posts of company commanders, guides	73	75	87
<i>Column in Route</i>			
Column in route	74	200	241
Change of direction and rate	75	214	255
Passing defiles	76	221, 198	263, 239
Deploying a Column into Line			
<i>At Full Distance</i>			
Formation of a line of battle	77	-	-
Markers	78	-	-
Successive formations	79	412	490
Left into line, from column	80	390	464
Posting Guides	81	395	469
Left wheel, to continue marching	82	403	478
On the right into line, no markers	83	414	502
On the right into line, with markers	84	414	502
By inversion, right into line	85	407	484
By inversion, right wheel	86	411	488
Forward into line	87	440	N/A
Forward into line, moving	88	451	N/A
Into line, faced to the rear	89	466	531
<i>At Half Distance</i>			
Open to full distance, to deploy left	90	501, 390	492, 464
By the rear of column, left into line	91	502	493
To the right, or faced to the rear	92	507, 509	502, 531
To deploy forward	93	508	530
			md p397
<i>Closed, In Mass</i>			
Move perpendicular and parallel	94	512	555
On the 1st company, deploy column	95	514	559
On the 4th company, deploy column	96	541	592
To deploy, while marching	97	532, 556	580, 610
To deploy on an inner company	98	563, 567	621, 626
To deploy to the right, or left	99	577	637

EVOLUTIONS

	PIE	Hardee II	Casey II
Maneuvering in Line			
To advance in line of battle	100	587-91	648-52
Point of direction	101	607	670
Rectifying disorder, the step	102	619, 621	682, 684
To march at an oblique	103	623	686
To halt the line, and post guides	104	635	699
To face by the rear rank	105	979	1218
To march in retreat	106	664	730
To march in retreat, without halting	107	678	747
Change direction while marching in line	108	652, 607	717, 670
<i>Changing Front</i>			
Change front forward on 1st company	109	743	830
Movement of 1st company	110	754	843
Change front forward on last company	111	759	850
Change front to the rear	112	761	852
Oblique change of front forward	113	775	872
Change front on non-flank companies	114	-	-
<i>Passing Obstacles</i>			
1st company, obstacle	115	682	753
1st company, into line	116	688	759
Move toward the center	117	708	784
Displaced companies march in same wing	118	682	753
<i>By the Right of Companies</i>			
To the front	119	105, 113	135, 150
To the rear, right about and into line	120	105, 116	135, 154
By file left	121	hc 314	cc 319
Column Doubled on the Center			
General description	122	776	874
When formed	123	794	898
<i>Forming the Double Column</i>			
Breaking files to the rear	124	777	875
Taking intervals	125	780	880
First division, second ..., &c.	126	784	885
Lieut. Col. ensures direction of Guides	127	785	886
Field Music in rear of column	128	786	888
If the Battalion had been moving	129	787	889
Maneuvering the column	130	794	898
Odd number of companies	131	792	896
<i>Deploying Forward</i>			
From a halt	132	796	946
While moving, into a halted line.	133	800	953
While moving, into a moving line	134	802	955
<i>Deploying to the Right or Left</i>			
A "composite" command	135	-	-
To deploy to the right from a halt	136	803	958
Deploying	137	806	962
While moving, into a halted line.	138	807	965
While moving, into a moving line	139	810	970
To deploy to the left	140	-	-
If the column is closed, in mass	141	-	-

EVOLUTIONS

	PIE	Hardee II	Casey II
The Color Guard and General Guides			
The Color and General Guides	142		LG p1
Post of the Guard	143	h36	c43
Composition of the Guard	144	h37	c44
			K 418
One Color is generally carried	145		md p164
If two Colors are carried	146		S 51
General Guides	147	620 h40-1	683 c47-8
			103, 121
Carrying the Color	148	h p215	c p225
Positions when Battalion advances in line	149	592, 636	653, 700
Posts of Guard during firings, a charge	150	41,38	47,44
			SA 1320
<i>Changing the General Alignment</i>			
Color and General Guides on the line	151	650	714
Movement of Color and Genl. Guides	152	640	704
Company guides on the line	153	641	705
Center dress	154	644	708
Color and guides - posts	155	647	711
Companies in front of new line	156	649	713
Field Music			
Post of music in line of battle	157	h34	c41
Post in column of maneuver	158	h p217	c p227
Post in column doubled on the center	159	786	888
Post in column in route	160	h p217	c p227
Facing by the rear rank	161	54	60
Field and Staff			
General comment	162	-	-
Posts in line of battle	163	h28	c35
Posts of Field Officers in advancing line	164	595, 602	657, 665
			SA 1320
Posts when marching by the right flank	165	727-8	812-3
Post when marching by the left flank	166	727-8	812-3
Post in column of companies, &c.	167	78	93
Responsibilities in column	168	168-9	223-4
Responsibilities when deploying into line	169	-	-
Adjutant and Sergt. Major responsibilities	170	h30	c37
Facing by the rear rank	171	54	60
Position of the Battalion Staff	172	-	-
Staff as Guides and Markers	173	-	-
Position of the Staff on Parade	174		R 337-48
Position of Staff on Review	175		R 349-74
Battalion Firing			
Color Guard	176	41, 38	47, 44
Posts of company commander, 1st Sergt.	177	hc 49	cc 49
To Fire by battalion	178	48	54
By wing	179	46	52
By company	180	35, 39	41, 45
By file	181	37, 50	43, 56
To cease firing	182	45	51
Direct and Oblique Firing	183	33	39

Assembly of the Battalion

The sources for *Assembly of the Battalion* are Vols. I & II of Scott's, Hardee's and Casey's various *Infantry Tactics*, the *United States Army Regulations*, Kautz's *Customs of Service for NCOs*, or Bruce and Emmett's *The Drummers' and Fifers' Guide*, Scott's *Abstract of Infantry Tactics*, and Butterfield's *Camp and Outpost Duty* ("B").

ASSEMBLY	PIE	
Assembly of the Battalion	184	various sources
Winfield Scott's <i>Abstract of Inf'y Tactics</i>	185	SA 804-9
Dan Butterfield's <i>Camp and Outpost</i>	186	B p69-72